

# Koyo®

## MINIATURE AND EXTRA-SMALL BALL BEARINGS



ISO9001/QS-9000  
Certificate No. 927265



**KOYO SEIKO CO., LTD.**

CAT.NO.295E

# CONTENTS

## Bearing Technical Section

<b>1. Bearing Types and Features</b>				<b>1</b>
1.1 Types and Features	2			
1.2 Designation Structure	4			<b>2</b>
1.3 Cages	6			
<b>2. Bearing Life and Load Rating</b>				<b>3</b>
2.1 Bearing Life	6			
2.2 Calculation of Bearing Life	7			<b>4</b>
2.3 Dynamic Equivalent Load	9			
2.4 Basic Static Load Rating and Static Equivalent Load	10			<b>5</b>
<b>3. Bearing Tolerances</b>				<b>6</b>
				<b>7</b>
<b>4. Rotation Speed Limit</b>				<b>8</b>
4.1 Correction of the Rotation Speed Limit	16			
4.2 Rotation Speed Limit for Sealed Deep Groove Ball Bearings	16			<b>9</b>
<b>5. Bearing Fits</b>				<b>10</b>
				<b>11</b>
<b>6. Bearing Internal Clearance</b>				<b>12</b>
				<b>13</b>
<b>7. Preload of Bearings</b>				
7.1 Objective of Preload	21			
7.2 Methods for Preloading	21			
7.3 Preload Force	21			
<b>8. Bearing Lubrication</b>				
8.1 Objective of Lubrication and Methods	22			
8.2 Grease Lubrication	22			
8.3 Oil Lubrication	22			
8.4 Grease Life of Shielded and Sealed Deep Groove Ball Bearings	24			
<b>9. Bearing Torque</b>				
<b>10. Bearing Materials</b>				
<b>11. Handling of Bearings</b>				
11.1 General Precautions for Handling	27			
11.2 Storage of Bearings	27			
11.3 Mounting Bearings	27			
11.4 Trial Run and Inspection	28			
11.5 Removal of Bearings	29			
<b>12. Ceramic Bearings</b>				
12.1 Properties of Ceramics	30			
12.2 Features of Ceramic Bearings	31			
12.3 Application Examples of Ceramic Bearings	32			
<b>13. Products Information</b>				

## Bearing Dimension Tables

### Metric series

<b>1. Deep Groove Ball Bearings - Standard series</b>	38	<b>1</b>
<b>2. Deep Groove Ball Bearings - Thin section series</b>	42	<b>2</b>
<b>3. Deep Groove Ball Bearings - Narrow-width series</b>	44	<b>3</b>
<b>4. Deep Groove Ball Bearings with Flanges - Standard series</b>	46	<b>4</b>
<b>5. Deep Groove Ball Bearings with Flanges - Thin section series</b>	50	<b>5</b>
<b>6. Deep Groove Ball Bearings with Resin Flanges - FN Bearings</b>	52	<b>6</b>

### Inch series

<b>7. Deep Groove Ball Bearings</b>	54	<b>7</b>
<b>8. Deep Groove Ball Bearings with Flanges</b>	56	<b>8</b>

## Supplementary Tables

<b>1. Bearing Number Correspondence Table</b>	58	<b>Supplementary Tables</b>
<b>2. Shaft Tolerances</b>	64	
<b>3. Housing Bore Tolerances</b>	66	
<b>4. Numerical Values for Standard Tolerance Grades IT</b>	68	
<b>5. Prefixes used with SI Units</b>	68	
<b>6. SI Units and Conversion Factors</b>	69	
<b>7. Inch/Millimeter Conversion</b>	73	
<b>8. Steel Hardness Conversion</b>	74	
<b>9. Viscosity Conversion</b>	75	



# **MINIATURE AND EXTRA-SMALL BALL BEARINGS**

---

**CAT.NO.295E**

● **VALUE & TECHNOLOGY**



## **New edition:**

### **MINIATURE AND EXTRA-SMALL BALL BEARINGS CATALOG**

#### **Preface**

Thank you for your valuable support of KOYO products. Recent industrial applications demand more sophistication in a variety of machines and equipment.

Rotation parts for information processing, audio, and visual equipment that include such features as high tolerance and low torque are highly desired by users.

To meet such demands, we at KOYO exploit state-of-the-art research facilities and leading-edge production methods to improve the performance and life of tolerance miniature and extra-small ball bearings.

The information contained in this catalog is the result of our research activities. We believe that this catalog will aid users in the selection and utilization of miniature and extra-small ball bearings.

Through our efforts in research and technical development, and by obtaining inspiration from the marketplace, KOYO can continually offer the best technologies, quality, and services.

We trust that you will be as satisfied with our latest products and services as you have been in the past.

The contents of this catalog are subject to change without prior notice. Every possible effort has been made to ensure that the data listed in this catalog is correct. However, we can not assume responsibility for any errors or omissions.

Reproduction of this catalog without written consent is strictly prohibited

## Bearing Technical Section

### CONTENTS

<b>1. Bearing Types and Features</b>		<b>1</b>
1.1 Types and Features	2	<b>2</b>
1.2 Designation Structure	4	<b>3</b>
1.3 Cages	6	<b>4</b>
<b>2. Bearing Life and Load Rating</b>		<b>5</b>
2.1 Bearing Life	6	<b>6</b>
2.2 Calculation of Bearing Life	7	<b>7</b>
2.3 Dynamic Equivalent Load	9	<b>8</b>
2.4 Basic Static Load Rating and Static Equivalent Load	10	<b>9</b>
<b>3. Bearing Tolerances</b>	11	<b>10</b>
<b>4. Rotation Speed Limit</b>		<b>11</b>
4.1 Correction of the Rotation Speed Limit	16	<b>12</b>
4.2 Rotation Speed Limit for Sealed Deep Groove Ball Bearings	16	<b>13</b>
<b>5. Bearing Fits</b>	17	
<b>6. Bearing Internal Clearance</b>	19	
<b>7. Preload of Bearings</b>		
7.1 Objective of Preload	21	
7.2 Methods for Preloading	21	
7.3 Preload Force	21	
<b>8. Bearing Lubrication</b>		
8.1 Objective of Lubrication and Methods	22	
8.2 Grease Lubrication	22	
8.3 Oil Lubrication	22	
8.4 Grease Life of Shielded and Sealed Deep Groove Ball Bearings	24	
<b>9. Bearing Torque</b>	24	
<b>10. Bearing Materials</b>	26	
<b>11. Handling of Bearings</b>		
11.1 General Precautions for Handling	27	
11.2 Storage of Bearings	27	
11.3 Mounting Bearings	27	
11.4 Trial Run and Inspection	28	
11.5 Removal of Bearings	29	
<b>12. Ceramic Bearings</b>		
12.1 Properties of Ceramics	30	
12.2 Features of Ceramic Bearings	31	
12.3 Application Examples of Ceramic Bearings	32	
<b>13. Products Information</b>	33	

# 1. Bearing Types and Features

## 1. Bearing Types and Features

Miniature and extra-small ball bearings include those with outer ring flanges, thin section types, and narrow-width types, as well as standard ones.

The above are also categorized as open, shielded, and sealed types.

### 1.1 Types and Features

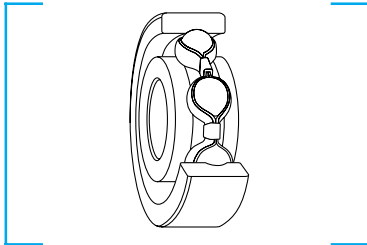

#### 1) Deep groove ball bearings

This type of bearing can carry a radial load and axial load in both directions simultaneously.

Featuring low frictional torque, it is suitable for applications where high rotation speed or low noise and vibration are required.

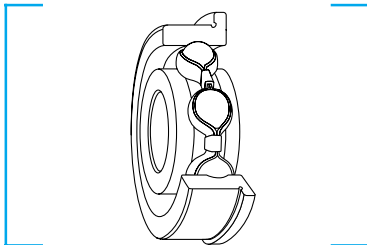

#### 2) Deep groove ball bearings with outer ring flange

This type of deep groove ball bearing has a flange on one end of the outside surface.

Since mounting is carried out using the side of the housing as reference, this type of bearing simplifies installation by easily positioning itself in the axial direction.

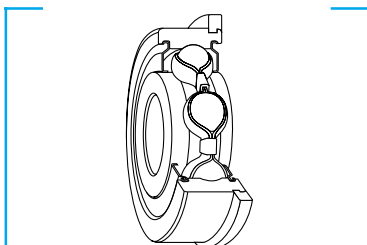

#### 3) Deep groove ball bearings with resin flange (FN bearings)

In this type of bearing a resin flange is injection molded around the outside surface, as an alternative to the solid outer ring flange.

This newly developed item is approximately 10 % lighter than a conventional deep groove ball bearing with an outer ring flange.

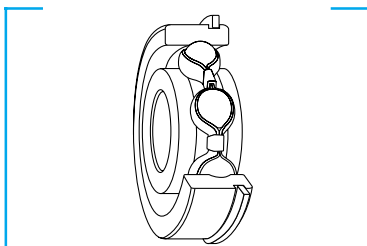

#### 4) Deep groove ball bearings with locating snap ring

With this type of bearing, mounting in a housing is simple, as its positioning in the axial direction is carried out using a locating snap ring.

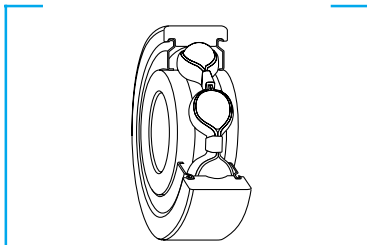

#### 5) Shielded and sealed ball bearings

These types of deep groove ball bearings are sealed by shields or rubber seals to prevent leakage of lubricating grease or entry of foreign matter.

Since the appropriate quantity of a high quality lubricating grease is factory sealed, the sealed deep groove ball bearing allows simplification of sealing devices around the bearing and facilitates easy handling.

**(1) Shielded ball bearings**

**ZZ (Z), ZZX (ZX)**

In this type of bearing, a press-worked shield is utilized. These bearings are classified as Z and ZX types according to the manner in which the shield is fixed to the outer ring. A ZL type, in which the inner ring is provided with a groove, is also available. A carbon steel or stainless steel plate is used for the shield.

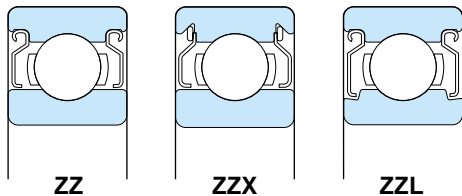

( ZZ, ZZX, ZL : dual-shielded type  
Z, ZX, ZL : single-shielded type )

**(2) Contact sealed ball bearings**

**2RS (RS), 2RD (RD)**

A contact rubber seal is included on this type of sealed deep groove ball bearing. This type of bearing offers excellent grease sealability and dust prevention as its structure is such that the seal lip is in contact with either the shoulder of the inner ring (outside surface of inner ring) or with the shoulder step. These bearings come in RS and RD types.

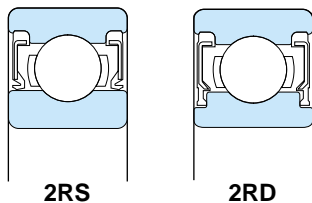

( 2RS, 2RD : dual-sealed type  
RS, RD : single-sealed type )

**Features of the RD seal**

The RD seal has a labyrinth structure in the shape of a letter Z formed by the seal lip and inner ring seal groove. The torque requirement of this type of bearing is as low as that of the non-contact type since the lip is extremely light contact with the seal groove of the inner ring, yet this newly developed item offers excellent grease sealability and dust prevention.

**(3) Non-contact sealed ball bearings**  
**2RU (RU), 2RJ3 (RJ3)**

This type of sealed deep groove ball bearing utilizes a rubber or resin non-contact seal. Since the labyrinth is formed between the seal lip and the seal groove step in the inner ring, it is superior in grease sealability and dust prevention. Being a non-contact type, it is suitable for high-speed applications with low frictional torque requirements.

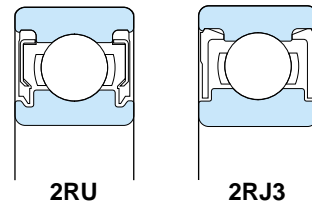

( 2RU, 2RJ3 : dual-sealed type  
RU, RJ3 : single-sealed type )

**Features of the RJ3 resin seal**

In a resin seal, resin is used in place of conventional rubber, offering high dust prevention ability.

**Reference: Dimensional ranges of miniature and extra - small ball bearings**

Table 1.1 shows dimensional ranges of miniature and extra-small ball bearings.

**Table 1.1 Dimensional Ranges of Miniature and Extra - small Ball Bearings**

Unit mm

Classification	Miniature Ball Bearing	Extra-small Ball Bearing
<b>Metric series</b>	Nominal bearing outside diameter $D < 9$ Nominal bearing bore diameter -	Nominal bearing outside diameter $D \quad 9$ Nominal bearing bore diameter $d < 10$
<b>Inch series</b>	Nominal bearing outside diameter $D < 9.525$ Nominal bearing bore diameter -	Nominal bearing outside diameter $D \quad 9.525$ Nominal bearing bore diameter $d < 10$

Remark: For bearings with a larger diameter than miniature and extra-small ball bearings, please refer to the comprehensive KOYO bearing catalog CAT. NO. 201E.

# 1. Bearing Types and Features

## 1.2 Designation Structure

The designation of a bearing indicates the specifications of

the bearing, such as bearing type, boundary dimensions, dimension accuracy, running accuracy, and internal clearance. It consists of a basic number and a supplementary code.

Table 1.2 Metric Series Deep Groove Ball Bearings (Standard Series)

Basic Number	Supplementary Code								
69 5	-1	ZZ	NR	M3	MG	P5	SR		
WF 68 3		ZZ		ST M2	YS	P0	KN		
<b>Bearing type code</b>									
No code : standard type W : wide type F : outer ring with flange FN : outer ring with resin flange									
<b>Bearing series code</b>									
68, 69, 60, 62, 63									
<b>Bore diameter number</b>									
1 ~ 9 : nominal bearing bore diameter									
<b>Specific item code</b>									
1 ~ : specific internal structure / 1D : specific bearing outside diameter / 1B : specific bearing width									
<b>Shield/seal code</b>									
Z, ZZ : single-shielded, dual-shielded ZX, ZZX : single-shielded, dual-shielded (with stop ring) RS, 2RS : single-sealed, dual-sealed (contact type) RD, 2RD : single-sealed, dual-sealed (extremely light contact type) RU, 2RU : single-sealed, dual-sealed (non-contact type) RJ 3, 2RJ 3 : single-sealed, dual-sealed (resin non-contact type)									
<b>Bearing ring form code</b>									
N : with snap ring groove NR : with snap ring groove and snap ring									
				<b>Material code</b>					
				No code : bearing steel ST : stainless steel					
				<b>Clearance code</b>					
				M1 : 0 ~ 5 μm    M4 : 8 ~ 13 μm M2 : 3 ~ 8 μm    M5 : 13 ~ 20 μm M3 : 5 ~ 10 μm    M6 : 20 ~ 28 μm					
				<b>Cage code</b>					
				/ / : steel plate – pressed cage YS : stainless steel plate – pressed cage MG : reinforced polyamide resin – molded cage FG : heat - resistant reinforced polyamide resin – molded cage					
				<b>Tolerance code</b>					
				P0 : JIS class 0    PZ : specific class (PZ1 - ) P6 : JIS class 6    5P : ABMA 5P P5 : JIS class 5    7P : ABMA 7P P4 : JIS class 4    9P : ABMA 9P P2 : JIS class 2					
				<b>Lubricant code</b>					
				<b>Oil</b> EF : Aero Shell fluid 12 <b>Grease</b> SR : Multemp SRL AC : Andok C P2 : Multemp PS2 B5 : Beacon 325 4M : SH44M BJ : Barrierta JFE552 KN : KNG144					

( For other greases, see Tables 8.2 and 8.3 on page 23 )



In general, boundary dimensions of bearings conform to JIS B 1512 (Boundary Dimensions for Rolling Bearings).

Designation of such standard bearings is specified by JIS B 1513 (Designation of Rolling Bearings).

In addition to JIS designation, KOYO uses supplementary codes, for ease of understanding of bearing specifications.

The designation structure is shown in Tables 1.2 to 1.4.

**Table 1.3 Metric Series Deep Groove Ball Bearings (Specific Dimension Series)**

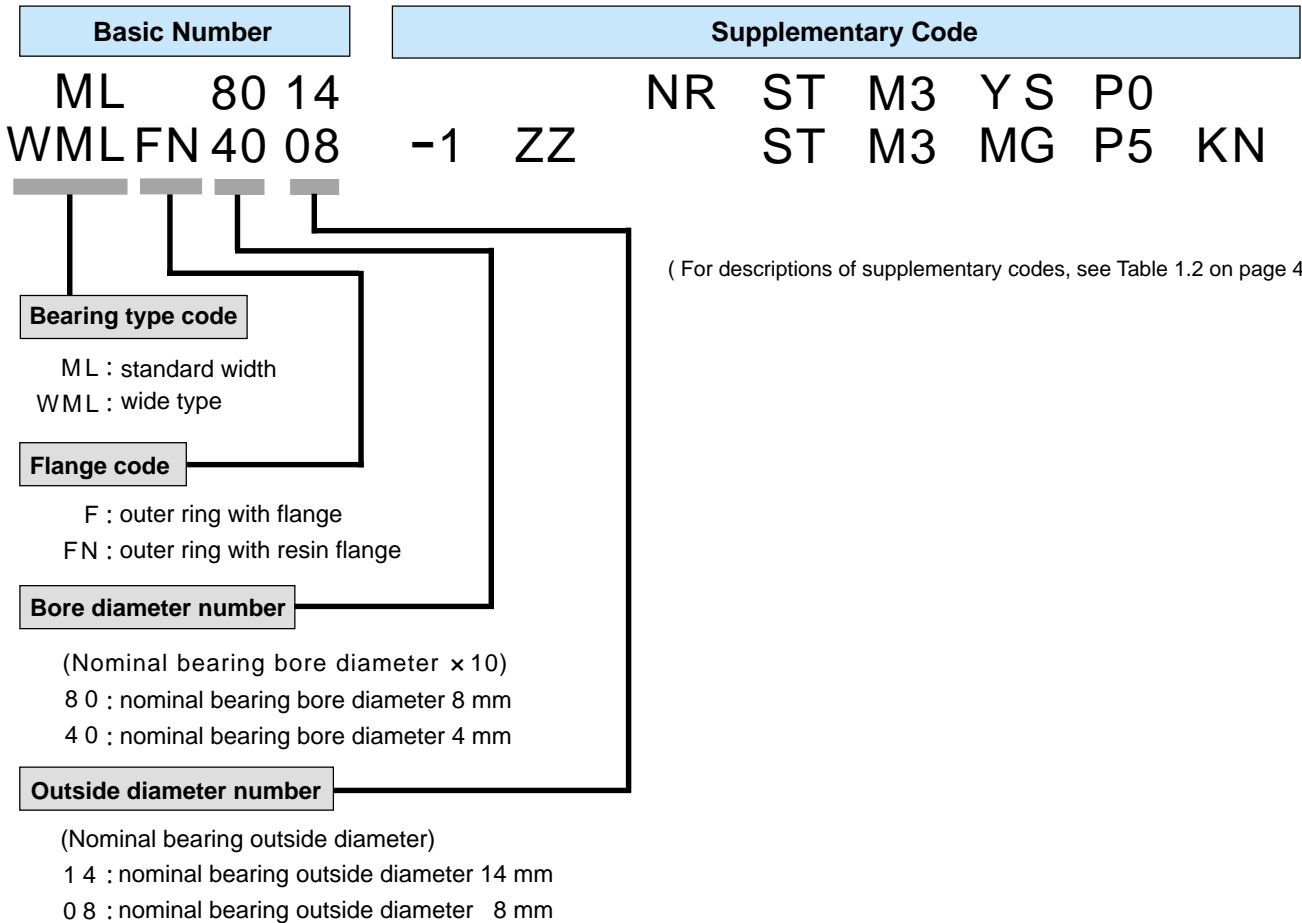

**Table 1.4 Inch Series Deep Groove Ball Bearings**

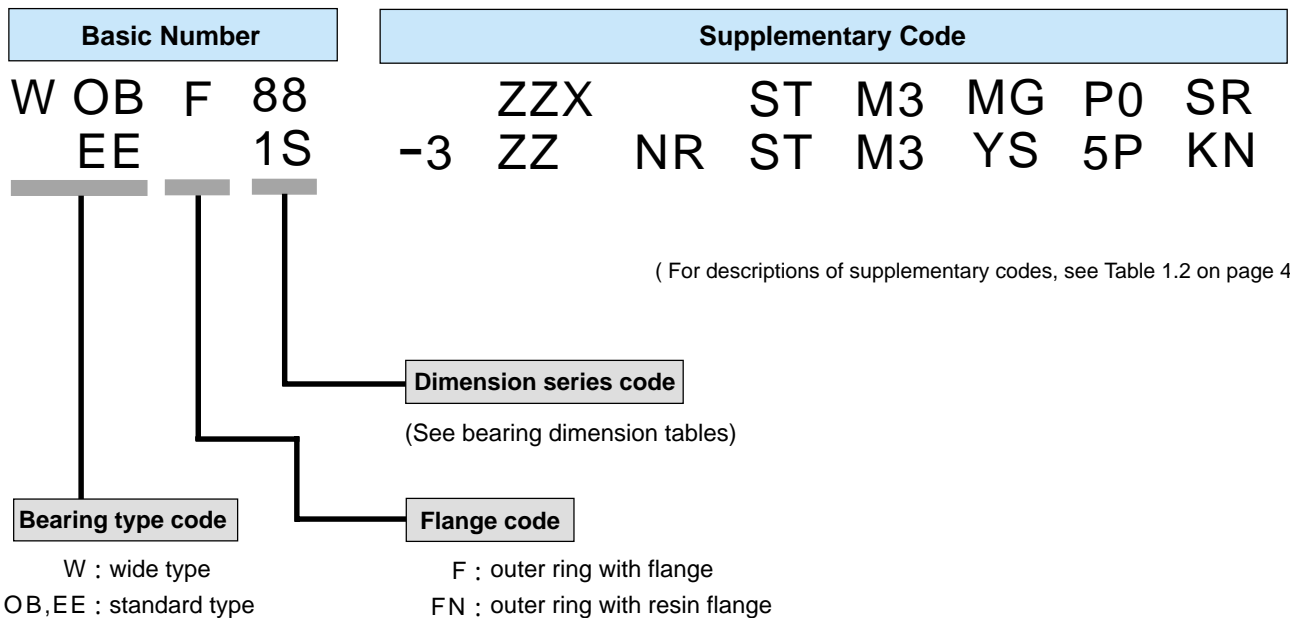

# 1. Bearing Types and Features

## 1.3 Cages

In general, a ribbon type or crown type cage made of steel is used in miniature and extra-small ball bearings.

The ribbon type cage is used in relatively large bearings, while the crown type is used in smaller ones.

Molded polyamide resin cages are becoming increasingly popular, as they are advantageous in terms of running torque, grease life, and noise.

The T-molded cage is designed to perform similarly to that of the single-shielded type bearing.

Table 1.5 shows types, codes, and names of cages used in miniature and extra-small ball bearings.

**Table 1.5 Cage Types, Codes, and Names**

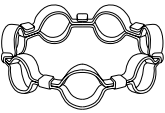
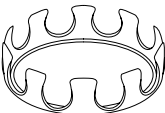
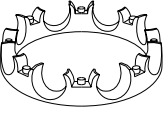
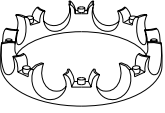
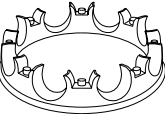
Cage Type	Code	Name
	YS //	Ribbon type cage
	YS	Crown type cage
	MG	Molded reinforced polyamide resin cage
	FG	Molded heat-resistant reinforced polyamide resin cage
	MG	T-molded reinforced polyamide resin cage

# 2. Bearing Life and Load Rating

## 2.1 Bearing Life

When a bearing rotates under a load, the raceway surfaces of the inner and outer rings and the rolling contact surfaces of the rolling elements are constantly subjected to repetitive loading.

Even under proper operating conditions this results in scale-like damage (known as flaking) on the surfaces of the raceway or surfaces of the rolling elements due to material fatigue.

The total number of rotations reached prior to this damage is known as "the (fatigue) life" of a bearing.

Substantial variations in fatigue life occur even if bearings of the same structure, dimensions, materials, machining method, etc. are operated under identical conditions.

This variation in fatigue life, an intrinsic phenomenon to the material, is being studied.

The total number of rotations at which 90 % of the same bearings operated individually under the same conditions should be free of damage caused by rolling fatigue (in other words, bearing life of 90 % reliability), is referred to as "the basic rating life."

If bearings are operated at a constant rate, the basic rating life is expressed in total running hours.

In miniature and extra-small ball bearings, it is rare that fatigue life becomes an issue of concern.

Factors affecting the service life of such bearings are the decline of bearing performance and deterioration of lubricant, which appear before flaking occurs.

Specifically, bearings used for audio and office automation equipment and aircraft instruments are required to offer a high level of noise, vibration, and frictional torque performance. Practical bearing life ends when a bearing becomes incapable of meeting its performance requirements.

## 2.2 Calculation of Bearing Life

### 2.2.1 Basic Dynamic Load Rating

The strength of a bearing against rolling fatigue—that is, the basic dynamic load rating representing the load-bearing capacity—is the net constant radial load (in the case of a radial bearing) that a bearing, with either the inner/outer ring stationary and the other rotating, can endure for a rating life of 1 million rotations.

This is known as "the basic dynamic radial load rating ( $C_r$ )."  
Its values are given in the bearing dimension tables.

### 2.2.2 Basic Rating Life

The relationship among the basic dynamic load rating, the dynamic equivalent load, and the basic rating life, is expressed by Equation (2.1).

If a bearing is to be operated at a constant rotation speed, its life is conveniently expressed in hours as determined by Equation (2.2).

**Total number of rotations**  $L_{10} = \left(\frac{C}{P}\right)^p \dots\dots\dots(2.1)$

**Hours**  $L_{10h} = \frac{10^6}{60n} \left(\frac{C}{P}\right)^p \dots\dots\dots(2.2)$

where,

$L_{10}$  : basic rating life,  $10^6$  rotations

$L_{10h}$  : basic rating life, h

$P$  : dynamic equivalent load, N  
..( See page 9 )

$C$  : basic dynamic load rating, N

$p$  :  $p = 3$  for ball bearings  
(  $p = 10/3$  for roller bearings)

$n$  : rotation speed,  $\text{min}^{-1}$

When a bearing is operated under a dynamic equivalent load  $P$  and rotation speed  $n$ , the basic dynamic load rating  $C$  of the bearing, which is adequate for meeting the design life, is given by Equation (2.3).

Thus, the dimensions of the bearing are determined by selecting a bearing from the bearing dimension tables, which meets the required dynamic load rating  $C$ .

$$C = P \left( L_{10h} \times \frac{60n}{10^6} \right)^{1/3} \dots\dots\dots(2.3)$$

**Reference**

The formula below is derived from Equation (2.2) by applying a life factor ( $f_h$ ) and speed factor ( $f_n$ ).

$$L_{10h} = 500 f_n^3 \dots\dots\dots(2.4)$$

$$\text{Life factor : } f_h = f_n \frac{C}{P} \dots\dots\dots(2.5)$$

$$\begin{aligned} \text{Speed factor : } f_n &= \left( \frac{10^6}{500 \times 60n} \right)^{1/3} \\ &= (0.03n)^{-1/3} \dots\dots\dots(2.6) \end{aligned}$$

Values of  $f_n$ ,  $f_h$ , and  $L_{10h}$  are determined approximately by nomograms as shown in Fig. 2.1.

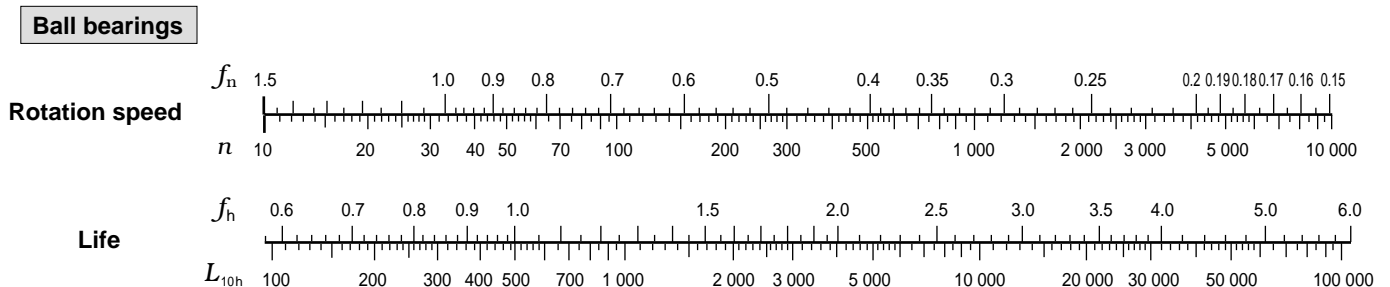

**Fig. 2.1** Rotation Speed ( $n$ ) vs. Speed Factor ( $f_n$ ) and Life Factor ( $f_h$ ) vs. Life ( $L_{10h}$ )

## 2. Bearing Life and Load Rating

### 2.2.3 Temperature Corrections for Basic Dynamic Load Ratings

When bearings are operated at high temperatures, their hardness decreases, and their material structure changes.

This results in a lower basic dynamic load rating than that determined by use at normal temperature.

Once the material structure has changed, it does not recover even if the temperature returns to normal.

Accordingly, the basic dynamic load ratings indicated in the bearing dimension tables must be corrected by multiplying by a temperature factor shown in Table 2.1.

**Table 2.1 Temperature Factor Values**

Bearing Temperature,	125	150	175	200	250
Temperature Factor	1	1	0.95	0.90	0.75

When a bearing which has undergone ordinary heat treatment is operated at 120 or higher for an extended period of time, a substantial dimensional change occurs.

There are bearings that have been subjected to dimension stabilizing treatment, whose codes and operating temperature ranges are shown in Table 2.2.

The hardness of such bearings, however, is low, so in some cases their basic dynamic load ratings may decrease.

**Table 2.2 Bearing Dimension Stabilizing Treatment**

Dimension Stabilizing Treatment Code	Operating Temperature Range
S 0	Over 100 , up to 150
S 1	Over 150 , up to 200
S 2	Over 200 , up to 250

### 2.2.4 Corrected Rating Life

The basic rating life ( $L_{10}$ ) expressed by Equation (2.1) is the (fatigue) life with 90 % reliability.

In some applications, the reliability should be higher than 90 % for calculating bearing life. Bearing life may be extended by adopting specific materials. In addition, operating conditions such as lubrication may affect bearing life.

The basic rating life is corrected by taking these conditions into consideration. Such bearing life is known as the corrected rating life, which is determined by Equation (2.7).

$$L_{na} = a_1 a_2 a_3 L_{10} \dots\dots\dots(2.7)$$

where,

$L_{na}$  : corrected rating life,  $10^6$  rotations

( Bearing life at (100 -  $n$ ) % reliability—namely, breakage probability  $n$  %—considering bearing characteristics and operating conditions )

$L_{10}$  : basic rating life,  $10^6$  rotations (90 % reliability)

$a_1$  : reliability factor .....See( 1 )

$a_2$  : bearing characteristic factor .....See( 2 )

$a_3$  : operating condition factor .....See( 3 )

[Note] When determining bearing dimensions using an  $L_{na}$  in which the reliability exceeds 90 %, consideration should be given to the design and strength of the shaft and housing

#### (1) Reliability factor, $a_1$

Table 2.3 shows  $a_1$  values used to determine the corrected rating life at reliabilities of 90 % or higher (10 % or less for breakage probability).

**Table 2.3 Reliability Factor,  $a_1$**

Reliability, %	$L_{na}$	$a_1$
90	$L_{10a}$	1
95	$L_{5a}$	0.62
96	$L_{4a}$	0.53
97	$L_{3a}$	0.44
98	$L_{2a}$	0.33
99	$L_{1a}$	0.21

**(2) Bearing characteristic factor,  $\alpha_2$**

The bearing characteristic variables pertaining to service life are bearing material (steel type and quality), manufacturing process, and design.

$\alpha_2$  is used for correction in such cases.

KOYO's standard material is a high-quality vacuum degassed bearing steel. The results of our tests show it to have substantial extended bearing life.

The basic load ratings of this material are indicated in the bearing dimension table, where the bearing characteristic factor is :  $\alpha_2 = 1$ .

For bearings using a specific material aimed at extending fatigue life, the value of  $\alpha_2$  can be greater than 1.

**(3) Operating conditions factor,  $\alpha_3$**

$\alpha_3$  is used for correction where a bearing operating condition has a direct influence on bearing life (especially, the adequacy of lubrication).

When lubrication is normal,  $\alpha_3 = 1$ .  $\alpha_3$  can be greater than 1 if the lubrication is especially good.

$\alpha_3 < 1$  under the conditions below.

Lubricant during operation has low kinematic viscosity

Ball bearings ..... 13 mm<sup>2</sup>/s { 13 cSt } max.

Roller bearings ... 20 mm<sup>2</sup>/s { 20 cSt } max.

Use at a very low rotation speed, where the product of pitch diameter of ball set and rotation speed ( $d_m n$ ) is 10 000 or smaller

Foreign matter enters lubricant

Inner and outer rings incline considerably

[Note] If the hardness of a bearing decreases during operation at high temperatures, a correction to the basic dynamic load rating is required (see Table 2.1 on page 8)

[Remark]

$\alpha_2 \times \alpha_3$  may not be greater than 1 when lubrication is inadequate, even if  $\alpha_2 > 1$  owing to the use of a specific material. Consequently, in general,  $\alpha_2 = 1$  if  $\alpha_3 < 1$

Since it is not easy to view  $\alpha_2$  and  $\alpha_3$  as independent factors, they are treated in some cases as a single factor,  $\alpha_{23}$

**2.3 Dynamic Equivalent Load**

Bearings are used under different conditions. For example, they are often subjected to a resultant load consisting of radial and axial loads, with their magnitudes being variable.

For convenience, a load of a constant magnitude and direction applied to the bearing center, is considered, which would make the bearing life equal to that resultant from an actual load and rotation speed.

This calculated virtual load is used to estimate bearing life, which is known as the dynamic equivalent load ( $P$ ).

The dynamic equivalent load of a radial bearing receiving a resultant load constant in magnitude and direction is obtained by Equation (2.8).

$$P = X F_r + Y F_a \dots\dots\dots(2.8)$$

where,

$P$  : dynamic equivalent load, N  
 ( For radial bearings,  $P_r$  : dynamic equivalent radial load )

$F_r$  : radial load, N

$F_a$  : axial load, N

$C_0$  : basic static load rating, N

$e$  : constant

$X$  : radial load factor (See Table 2.4)

$Y$  : axial load factor (See Table 2.4)

**Table 2.4 Radial and Axial Load Factors of Deep Groove Ball Bearings**

$\frac{F_a}{C_0}$	$e$	$\frac{F_a}{F_r} \leq e$		$\frac{F_a}{F_r} > e$	
		$X$	$Y$	$X$	$Y$
0.014	0.19	1	0	0.56	2.30
0.028	0.22				1.99
0.056	0.26				1.71
0.084	0.28				1.55
0.11	0.30				1.45
0.17	0.34				1.31
0.28	0.38				1.15
0.42	0.42				1.04
0.56	0.44				1.00

## 2. Bearing Life and Load Rating

### 2.4 Basic Static Load Rating and Static Equivalent Load

#### 2.4.1 Basic Static Load Rating

Under an excessive static load or with an impact load at very low rotation speed, bearings can experience local permanent deformation of the contact surfaces between the rolling elements and raceways.

The magnitude of this permanent deformation increases as the load becomes greater. This will eventually impair the bearings ability to operate smoothly.

The basic static load rating refers to the static load corresponding to the following calculated contact stress, which is working at the center of contact between the rolling element and raceway where the maximum load is applied.

- Deep groove ball bearings ..... 4 200 MPa
- Self-aligning ball bearings ..... 4 600 MPa
- Roller bearings ..... 4 000 MPa

The total permanent deformation of the rolling element and raceway occurring under such contact stress as indicated above is approximately 0.000 1 times the diameter of the rolling element.

The static load rating of radial bearings is known as the basic static radial load rating ( $C_{0r}$ ). Its values are shown in the bearing dimension tables.

#### 2.4.2 Static Equivalent Load

The static equivalent load is also a calculated virtual load.

The magnitude of this load is determined through conversion, such that the load would produce a contact stress equal to that produced under actual loading conditions, occurring at the center of contact between the rolling element and raceway under maximum load while the bearing is at rest or rotating at a very low rate.

For radial bearings, the radial load working at the bearing center is employed, which is referred to as the static equivalent radial load ( $P_{0r}$ ).

The static equivalent load is obtained by Equations (2.9) and (2.10).

[Radial bearing] ... The larger of the values determined by the following two equations is adopted.

$$P_{0r} = X_0 F_r + Y_0 F_a \quad \dots\dots\dots(2.9)$$

$$P_{0r} = F_r \quad \dots\dots\dots(2.10)$$

where,

$P_{0r}$  : static equivalent radial load, N

$F_r$  : radial load, N

$F_a$  : axial load, N

$X_0$  : static radial load factor (0.6)

$Y_0$  : static axial load factor (0.5)

#### 2.4.3 Safety Factor

The permissible static equivalent load is determined by the basic static load rating of the bearing.

The operating limits of a bearing with permanent deformation (local dent) as described in the preceding section depends on the bearing's performance requirements and operating conditions.

To estimate the degree of safety ensured for a basic static load rating, a safety factor is determined through experience.

$$f_s = \frac{C_0}{P_0} \quad \dots\dots\dots(2.11)$$

where,

$f_s$  : safety factor (See Table 2.5)

$C_0$  : basic static load rating, N

$P_0$  : static equivalent load, N

**Table 2.5 Values of Safety Factor  $f_s$**

Operating Condition	$f_s$ (min.)	
	Ball Bearing	Roller Bearing (Reference)
High running accuracy required	2	3
Ordinary operating condition	1	1.5
Impact load involved	1.5	3

### 3. Bearing Tolerances

The main factor to consider when selecting the bearing tolerances is application.

Table 3.1 shows standards used to select the tolerances of miniature and extra-small ball bearings. Use this table as a reference when determining the required bearing tolerances.

The tolerance classes of miniature and extra-small ball bearings are specified in JIS B 1514 (Tolerances for Rolling Bearings) (JIS is based on ISO standards).

The tolerance classes of inch series deep groove ball bearings conform to ABMA standards.

The tolerance classes for these bearings are as follows:

- Metric series deep groove ball bearings  
JIS Classes 0, 6, 5, 4, and 2
- Inch series deep groove ball bearings  
ABMA Standard 5P, 7P, and 9P

Table 3.2 shows the limits for chamfer dimensions and Tables 3.3 to 3.5 show bearing tolerances of miniature and extra-small ball bearings .

Reference: Standards and Organizations Related to Bearings

- JIS : Japanese Industrial Standards
- ISO : International Organization for Standardization
- ANSI : American National Standards Institute, Inc.
- ABMA : American Bearing Manufacturers Association

**Table 3.1 Tolerance Classes Selection Standard for Miniature and Extra-small Ball Bearings**

Application	Tolerance Class
Printers Copying machines Pinch rollers Stepping motors Electric power tools ABS motors Electric fan motors	Classes 0 and 6
Small motors Axial flow fan motors Floppy disk drive motors Tape guide motors Rotary encoders Servo motors Synchro motors Cleaner motors Dental hand piece Magnetic disc drive pivot	Classes 5 and 4 ABMA 5P and 7P
Precision motors Magnetic disc spindle motors VTR cylinder motors Polygon mirror scanner motors	Classes 4 and 2 ABMA 7P and 9P

**Table 3.2 Permissible Values for Chamfer Dimensions (Radial Bearing) = JIS B 1514 = Unit mm**

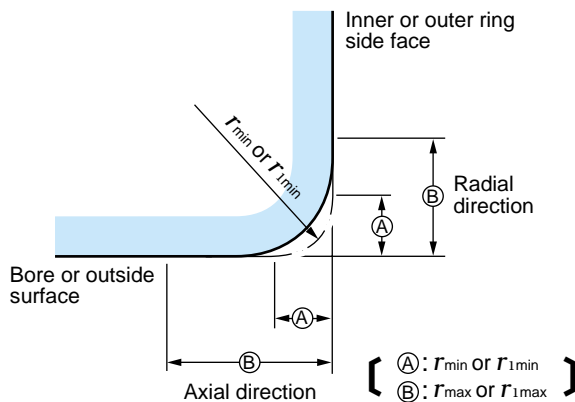

$r_{min}$ OR $r_{1min}$	Radial Direction	Axial Direction
	$r_{max}$ OR $r_{1max}$	
0.05	0.1	0.2
0.08	0.16	0.3
0.1	0.2	0.4
0.15	0.3	0.6
0.2	0.5	0.8
0.3	0.6	1
0.6	1	2

- Remarks: 1. Value of  $r_{max}$  or  $r_{1max}$  in the axial direction of bearings with nominal width lower than 2 mm shall be the same as the value in radial direction
2. There shall be no specification for the accuracy of the shape of the chamfer surface, but its outline in the axial plane shall not be situated outside of the imaginary circle arc with a radius of  $r_{min}$  or  $r_{1min}$  which contacts the inner ring side face and bore, or the outer ring side face and outside surface

### 3. Bearing Tolerances

Table 3.3 (1) Tolerances for Metric Series Deep Groove Ball Bearings – Inner Rings–

(1) Inner ring (bore diameter)

Unit  $\mu\text{m}$

Class	Nominal bore diameter $d$ (mm)		Single plane mean bore diameter deviation $d_{mp}$		Single bore diameter deviation $d_s$		Single radial plane bore diameter variation $Vd_p$			Mean bore diameter variation $Vd_{mp}$
	over	up to	upper	lower	upper	lower	Diameter series			
							7,8,9 max.	0,1 max.	2,3,4 max.	max.
Class 0	0.6 <sup>1)</sup> 2.5	2.5 10	0	-8	—	—	10	8	6	6
Class 6	0.6 <sup>1)</sup> 2.5	2.5 10	0	-7	—	—	9	7	5	5
Class 5	0.6 <sup>1)</sup> 2.5	2.5 10	0	-5	—	—	5	4		3
Class 4	0.6 <sup>1)</sup> 2.5	2.5 10	0	-4	0	-4 <sup>2)</sup>	4	3		2
Class 2	0.6 <sup>1)</sup> 2.5	2.5 10	0	-2.5	0	-2.5	—	2.5		1.5

(2) Inner ring (running accuracy and width)

Unit  $\mu\text{m}$

Class	Nominal bore diameter $d$ (mm)		Radial runout of assembled bearing inner ring $K_{ia}$	Face runout with bore $S_d$	Face runout with raceway $S_{ia}$	Single inner ring width deviation $B_s$				Inner ring width variation $V B_s$
	over	up to				Single row bearing		Bearing for paired or stacked mounting <sup>3)</sup>		
			upper	lower	upper	lower	max.			
Class 0	0.6 <sup>1)</sup> 2.5	2.5 10	10	—	—	0	-40	—	—	12
Class 6	0.6 <sup>1)</sup> 2.5	2.5 10	5 6	—	—	0	-40	—	—	12
Class 5	0.6 <sup>1)</sup> 2.5	2.5 10	4	7	7	0	-40	0	-250	5
Class 4	0.6 <sup>1)</sup> 2.5	2.5 10	2.5	3	3	0	-40	0	-250	2.5
Class 2	0.6 <sup>1)</sup> 2.5	2.5 10	1.5	1.5	1.5	0	-40	0	-250	1.5

- Notes: 1) In this dimension classification, 0.6 mm is included  
 2) Applicable to bearings of diameter series 0, 1, 2, 3, and 4  
 3) Applicable to individual bearing rings fabricated for paired or stacked mounting

Remarks:

- The upper tolerances for the bore diameters of cylindrical bore bearings specified in this table do not apply to the area from the bearings ring side face through 1.2 times the maximum permissible chamfer dimension  $r_{max}$
- According to revised ANSI / ABMA std 20, ABEC 1, 3, 5, 7, and 9 correspond to Classes 0, 6, 5, 4, and 2, respectively

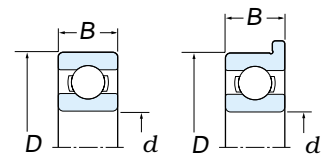

$d$  : nominal bearing bore diameter  
 $D$  : nominal bearing outside diameter  
 $B$  : nominal bearing width



Table 3.3 (2) Tolerances for Metric Series Deep Groove Ball Bearings – Outer Rings–

(1) Outer ring (outside diameter)

Unit  $\mu\text{m}$

Class	Nominal outside diameter $D$ (mm)		Single plane mean outside diameter deviation $D_{mp}$		Single outside diameter deviation $D_s$ <sup>2)</sup>		Single radial plane outside diameter variation $VD_p$ <sup>3)</sup>				Mean outside diameter variation $VD_{mp}$ <sup>3)</sup>
							Open type			Shielded / sealed type	
	Diameter series			Diameter series							
	7,8,9	0,1	2,3,4	0,1,2,3,4							
	over	up to	upper	lower	upper	lower	max.	max.	max.	max.	max.
Class 0	2.5 <sup>1)</sup>	18	0	-8	—	—	10	8	6	10 <sup>4)</sup>	6
	18	30	0	-9	—	—	12	9	7	12 <sup>4)</sup>	7
Class 6	2.5 <sup>1)</sup>	18	0	-7	—	—	9	7	5	9	5
	18	30	0	-8	—	—	10	8	6	10	6
Class 5	2.5 <sup>1)</sup>	18	0	-5	—	—	5	4		—	3
	18	30	0	-6	—	—	6	5		—	3
Class 4	2.5 <sup>1)</sup>	18	0	-4	0	-4	4	3		—	2
	18	30	0	-5	0	-5	5	4		—	2.5
Class 2	2.5 <sup>1)</sup>	18	0	-2.5	0	-2.5	—	2.5		—	1.5
	18	30	0	-4	0	-4	—	4		—	2

(2) Outer ring (running accuracy and width)

Unit  $\mu\text{m}$

Class	Nominal outside diameter $D$ (mm)		Radial runout of assembled bearing outer ring $K_{ea}$	Variation of outside surface generatrix inclination with face $S_D$ <sup>5)</sup>	Assembled bearing outer ring face runout with raceway $S_{ea}$ <sup>5)</sup>	Deviation of a single outer ring width $C_s$		Outer ring width variation $VC_s$	
						upper	lower		
	over	up to	max.	max.	max.			max.	
Class 0	2.5 <sup>1)</sup>	18	15	—	—	Refer to the tolerance for $B_s$ , with $d$ being that of the same bearing		Refer to the tolerance for $VB_s$ , with $d$ being that of the same bearing	
	18	30	15	—	—				
Class 6	2.5 <sup>1)</sup>	18	8	—	—				
	18	30	9	—	—				
Class 5	2.5 <sup>1)</sup>	18	5	8	8				5
	18	30	6	8	8				5
Class 4	2.5 <sup>1)</sup>	18	3	4	5	2.5			
	18	30	4	4	5	2.5			
Class 2	2.5 <sup>1)</sup>	18	1.5	1.5	1.5	1.5			
	18	30	2.5	1.5	2.5	1.5			

- Notes: 1) In this dimension classification, 2.5 mm is included  
 2) Applicable to bearings of diameter series 0, 1, 2, 3, and 4  
 3) Applicable where no locating snap ring is fitted  
 4) Applicable to bearings of diameter series 2, 3, and 4  
 5) Not applicable to flanged bearings

Remarks:

- The lower tolerances for the outside diameters of the bearings specified in this table do not apply to the area from the side face of bearings ring through 1.2 times the maximum permissible chamfer dimension  $r_{max}$
- According to revised ANSI / ABMA std 20, ABEC 1, 3, 5, 7, and 9 correspond to Classes 0, 6, 5, 4, and 2, respectively

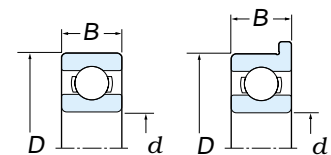

$d$  : nominal bearing bore diameter  
 $D$  : nominal bearing outside diameter  
 $B$  : nominal bearing width

### 3. Bearing Tolerances

Table 3.4 Tolerances for Flanges of Flanged Deep Groove Ball Bearings

(1) Tolerance for flange outside diameter Unit  $\mu\text{m}$

Nominal flange outside diameter $D_1$ (mm)		Field 1		Field 2	
		Single flange outside diameter deviation $D_{1s}$			
over	up to	upper	lower	upper	lower
	10	+ 220	- 36	0	- 36
10	18	+ 270	- 43	0	- 43
18	30	+ 330	- 52	0	- 52

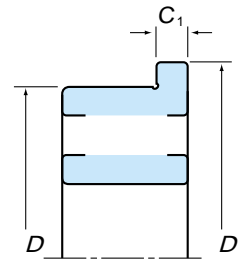

- Remarks:
- Field 2 is applicable when the outside surface of the flange is used for positioning
  - For the tolerance of deep groove ball bearings with resin flanges (FN bearings), see the bearing dimension table

$D$  : nominal bearing outside diameter  
 $D_1$  : nominal flange outside diameter  
 $C_1$  : nominal flange width

(2) Tolerances for flange width, and running accuracy related to the flange

Unit  $\mu\text{m}$

Class	Nominal outside diameter $D$ (mm)		Single flange width deviation $C_{1s}$		Flange width variation $VC_{1s}$	Variation of outside surface generatrix inclination with flange back face $S_{D1}$	Flange back face runout with raceway $S_{ea1}$
	over	up to	upper	lower	max.	max.	max.
Class 0	2.5 <sup>1)</sup>	18	Refer to the tolerance for $B_s$ of the same class, with $d$ being that of the same bearing		Refer to the tolerance for $VB_s$ of the same class, with $d$ being that of the same bearing	—	—
Class 6	18	30				—	—
Class 5	2.5 <sup>1)</sup>	18			5	8	11
Class 4	18	30			5	8	11
					2.5	4	7
Class 2	2.5 <sup>1)</sup>	18			2.5	4	7
			18	30	1.5	1.5	3
					1.5	4	

Note: 1) In this dimension classification, 2.5 mm is included

Remark: Tolerances specified in this table are not applicable to deep groove ball bearings with resin flanges (FN bearings)

**Table 3.5 (1) Tolerances for Inch Series Deep Groove Ball Bearings – Inner Rings –**

**(1) Inner ring (bore diameter)  $d \geq 10$  mm**

Unit  $\mu\text{m}$

Class	Single plane mean bore diameter deviation		Single bore diameter deviation		Single radial plane bore diameter variation	Mean bore diameter variation
	$d_{mp}$		$d_s$		$Vd_p$	$Vd_{mp}$
	upper	lower	upper	lower	max.	max.
ABMA 5P	0	-5.1	0	-5.1	2.5	2.5
ABMA 7P	0	-5.1	0	-5.1	2.5	2.5
ABMA 9P	0	-2.5	0	-2.5	1.3	1.3

**(2) Inner ring (running accuracy and width)  $d \geq 10$  mm**

Unit  $\mu\text{m}$

Class	Radial runout of assembled bearing inner ring	Face runout with bore	Face runout with raceway	Single inner ring width deviation		Inner ring width variation
	$K_{ia}$	$S_d$	$S_{ia}$	$B_s$		$VB_s$
	max.	max.	max.	upper	lower	max.
ABMA 5P	3.8	7.6	7.6	0	-25.4	5.1
ABMA 7P	2.5	2.5	2.5	0	-25.4	2.5
ABMA 9P	1.3	1.3	1.3	0	-25.4	1.3

**Table 3.5 (2) Tolerances for Inch Series Deep Groove Ball Bearings – Outer Rings –**

**(1) Outer ring (outside diameter)**

Unit  $\mu\text{m}$

Class	Nominal outside diameter		Single plane mean outside diameter deviation		Open type			Shielded / sealed type				
					Single outside diameter deviation	Single radial plane outside diameter variation	Mean outside diameter variation	Single outside diameter deviation	Single radial plane outside diameter variation	Mean outside diameter variation		
	$D$		$D_{mp}$		$D_s$		$VD_p$	$VD_{mp}$	$D_s$	$VD_p$	$VD_{mp}$	
	over	up to	upper	lower	upper	lower	max.	max.	upper	lower	max.	max.
ABMA 5P	—	18	0	-5.1	0	-5.1	2.5	2.5	+1	-6.1	5.1	5.1
ABMA 7P	—	18	0	-5.1	0	-5.1	2.5	2.5	+1	-6.1	5.1	5.1
ABMA 9P	—	18	0	-2.5	0	-2.5	1.3	1.3	—	—	—	—
	18	30	0	-3.8	0	-3.8	2	2				

**(2) Outer ring (running accuracy, width and flange tolerances)**

Unit  $\mu\text{m}$

Class	Nominal outside diameter		Radial runout of assembled bearing outer ring	Variation of outside surface generatrix inclination with face	Assembled bearing outer ring face runout with raceway	Deviation of a single outer ring width	Outer ring width variation	With outer ring flange						
								Single flange outside diameter deviation	Single flange width deviation	Flange width variation	Flange back face runout with raceway			
	$D$		$K_{ea}$	$S_D$	$S_{ea}$	$C_s$	$VC_s$	$D_{1s}$	$C_{1s}$	$VC_1$	$S_{ea1}$			
over	up to	max.	max.	max.	upper	lower	max.	upper	lower	max.	max.			
ABMA 5P	—	18	5.1	7.6	7.6	0	-25.4	5.1	0	-25.4	0	-50.8	5.1	7.6
ABMA 7P	—	18	3.8	3.8	5.1	0	-25.4	2.5	0	-25.4	0	-50.8	2.5	5.1
ABMA 9P	—	18	1.3	1.3	1.3	0	-25.4	1.3	—	—	—	—	—	—
	18	30	2.5	2.5	2.5	0	-25.4	1.3						

## 4. Rotation Speed Limit

### 4. Rotation Speed Limit

The rotation speed of a bearing is restricted chiefly by temperature increases caused by frictional heat generated in the bearing. When the speed limit is reached, it becomes impossible to continue operation due to seizure and the like.

The limit on rotation speed of a bearing represents the maximum value at which the bearing can continue operation without generating seizure-causing heat.

Accordingly, the rotation speed limit differs with each bearing type, dimensions, and accuracy, as well as with lubrication methods, quality and quantity of lubricant, cage material, loading conditions, etc.

The rotation speed limit for grease lubrication or oil (oil bath) lubrication of each bearing is given in the dimension table.

These values are applicable in cases where a bearing of a standard design is operated under normal loading conditions ( $C/P \geq 13$ ,  $F_a/F_r \approx 0.25$ ).

(  $C$  : basic dynamic load rating       $F_r$  : radial load )  
 (  $P$  : dynamic equivalent load       $F_a$  : axial load )

The classes and brands of some lubricants may not be suitable for high-speed operation even if they are excellent in other features.

Consult KOYO if the rotation speed of a bearing exceeds 80 % of the catalog value.

#### 4.1 Correction of the Rotation Speed Limit

Under some loading conditions, the rotation speed limit needs to be corrected by Equation (4.1).

Such conditions include cases where  $C/P < 13$  (namely, the dynamic equivalent load  $P$  is equal to or greater than approximately 8 % of the basic dynamic load rating  $C$ ), and in combined loading applications where the axial load exceeds 25 % of the radial load.

$$n_a = f_1 \cdot f_2 \cdot n \quad \dots\dots\dots (4.1)$$

where,

- $n_a$  : corrected rotation speed limit,  $\text{min}^{-1}$
- $f_1$  : correction factor determined from the load magnitude (See Fig. 4.1)
- $f_2$  : correction factor determined from combined load (See Fig. 4.2)
- $n$  : rotation speed limit under normal load condition (listed in the bearing dimension table),  $\text{min}^{-1}$
- $C$  : basic dynamic load rating, N
- $P$  : dynamic equivalent load, N
- $F_r$  : radial load, N
- $F_a$  : axial load, N

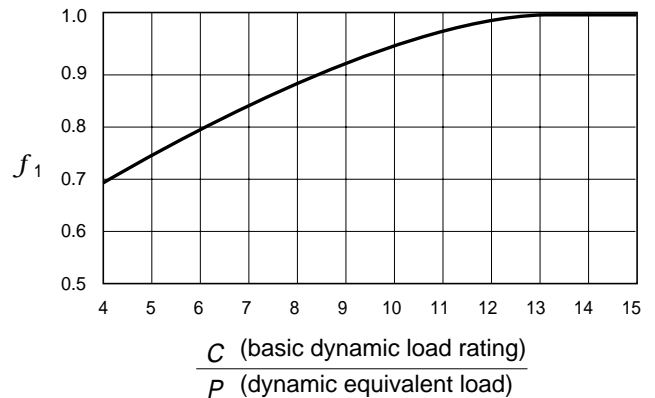

Fig. 4.1 Values of the Correction Factor  $f_1$  Determined by Load Magnitude

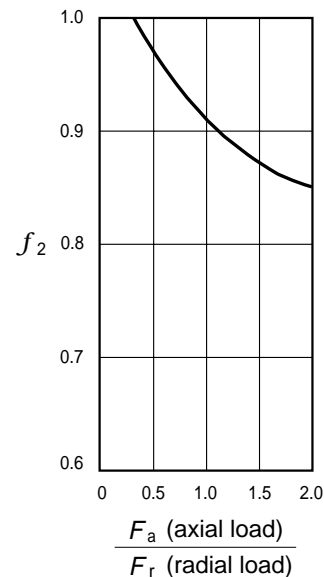

Fig. 4.2 Values of the Correction Factor  $f_2$  Determined by Combined Load

#### 4.2 Rotation Speed Limit for Sealed Deep Groove Ball Bearings

The rotation speed limit for a deep groove ball bearing with contact seals is limited by the rubbing speed of the portion in contact with the seal.

This allowable rubbing speed varies according to the rubber material of the seal.

In KOYO's deep groove ball bearings with standard RS type contact seals (nitrile rubber), 15 m/s is used.

The rotation speed limit for individual deep groove ball bearings with seals is given in the relevant bearing dimension table.

## 5. Bearing Fits

In general, light interference fits or slight clearance fits are used for miniature and extra-small ball bearings. Fits of considerable interference or clearance can be detrimental.

Selective fitting is recommended if it is possible to select shafts and housings with bearings classified according to bore and outside diameters.

Selective fitting helps narrow down the range of fits so that bearing performance can be effectively improved.

In miniature and extra-small ball bearings, housings made of non-ferrous metal such as an aluminum alloy are frequently used. In applications with wide temperature ranges, the housings should be fitted with a steel liner.



At low temperatures, the steel liner prevents housing shrinkage and at high temperatures, it minimizes expansion.

Table 5.1 shows fits for tolerance miniature and extra-small ball bearings.

**Table 5.1 Fits for Precision Miniature and Extra-small Ball Bearings (JIS Classes 5 and 4, ABMA 5P and 7P)**

(1) Fit on shaft ( $d < 10 \text{ mm}$ )

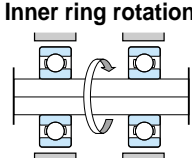
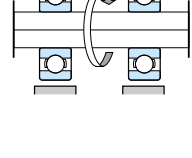
Unit  $\mu\text{m}$

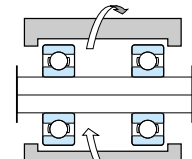
Operating Condition	Principal Application	Fit	Bearing Class	Single plane mean bore diameter deviation $d_{mp}$		Shaft diameter dimensional tolerance		Fit <sup>1)</sup>	
				upper	lower	upper	lower		
 Inner ring rotation	<b>Medium / high speed</b> Cleaner motors Electric power tools Encoders	<b>Light interference fit</b>	<b>ABMA 5P</b>	0	-5.1	+2.5	-2.5	7.6T	2.5L
			<b>JIS Class 5</b>	0	-5			7.5T	2.5L
	<b>ABMA 7P</b>		0	-5.1	+2.5	-2.5	7.6T	2.5L	
	<b>JIS Class 4</b>		0	-4			6.5T	2.5L	
 Low speed Light load	Synchronized instruments Servo motors Floppy disk drive spindles	<b>Slight clearance fit</b>	<b>ABMA 5P</b>	0	-5.1	-2.5	-7.5	2.6T	7.5L
			<b>JIS Class 5</b>	0	-5			2.5T	7.5L
			<b>ABMA 7P</b>	0	-5.1	-2.5	-7.5	2.6T	7.5L
			<b>JIS Class 4</b>	0	-4			1.5T	7.5L
 Outer ring rotation	<b>Medium / high speed</b> VTR cylinder motors Polygon mirror scanner motors	<b>Selective fit required</b>	<b>ABMA 7P</b>	0	-5.1	-1	-6	-	1 L
			<b>JIS Class 4</b>	0	-4	-1	-5		
 Low to high speed Light load	Magnetic disc drive spindles Pinch rollers Tape guide rollers	<b>Slight clearance fit</b>	<b>ABMA 5P</b>	0	-5.1	-2.5	-7.5	2.6T	7.5L
			<b>JIS Class 5</b>	0	-5			2.5T	7.5L
			<b>ABMA 7P</b>	0	-5.1	-2.5	-7.5	2.6T	7.5L
			<b>JIS Class 4</b>	0	-4			1.5T	7.5L

Note: 1) Symbol T denotes interference, and L, clearance

## 5. Bearing Fits

### (2) Fit in housing ( $D \leq 30$ mm )

Unit  $\mu\text{m}$

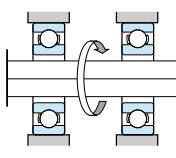
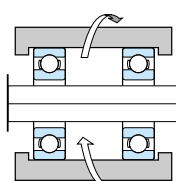
Operating Condition	Principal Application	Fit	Bearing Class	Single plane mean outside diameter deviation $D_{mp}$		Housing bore diameter dimensional tolerance		Fit <sup>1)</sup>	
				upper	lower	upper	lower		
<b>Inner ring rotation</b> 	<b>Medium / high speed</b> Cleaner motors  <b>Light / medium load</b> Electric power tools  Encoders	Clearance fit	ABMA 5P	0	-5.1	+5	0	0	10.1L
			ABMA 7P	0	-5	+5	0	0	10 L
			JIS Class 5 <sup>2)</sup>	0	-6	+5	0	0	11 L
	<b>Low speed</b> Synchronized instruments  <b>Light load</b> Servo motors  Floppy disk drive spindles	Slight clearance fit	ABMA 5P	0	-5.1	+2.5	-2.5	2.5T	7.6L
			ABMA 7P	0	-5	+2.5	-2.5	2.5T	7.5L
			JIS Class 5 <sup>2)</sup>	0	-6	+2.5	-2.5	2.5T	8.5L
	<b>Medium / high speed</b> Polygon mirror scanner motors  <b>Light load</b> VTR cylinder motors	Slight clearance fit	ABMA 7P	0	-5.1	+3	0	0	8.1L
			JIS Class 4 <sup>2)</sup>	0	-4	+3	0	0	7 L
		JIS Class 4 <sup>2)</sup>	0	-5	+3	0	0	8 L	
<b>Outer ring rotation</b> 	<b>Low to high speed</b> Magnetic disc drive spindles  <b>Light load</b> Pinch rollers  Tape guide rollers	Slight clearance fit	ABMA 5P	0	-5.1	+2.5	-2.5	2.5T	7.6L
			ABMA 7P	0	-5	+2.5	-2.5	2.5T	7.5L
			JIS Class 5 <sup>2)</sup>	0	-6	+2.5	-2.5	2.5T	8.5L
	<b>Light load</b> Tape guide rollers	Slight clearance fit	JIS Class 4 <sup>2)</sup>	0	-4	+2.5	-2.5	2.5T	6.5L
			JIS Class 4 <sup>2)</sup>	0	-5	+2.5	-2.5	2.5T	7.5L
			JIS Class 4 <sup>2)</sup>	0	-5	-2	-5	5 T 2 L	5 T 3 L

Notes: 1) Symbol T denotes interference, and L, clearance

2) The figures for the upper and lower rows in the fields indicating the tolerances for the bearing outside diameter and fit for JIS Classes 5 and 4, are applicable in cases where  $D \leq 18$  mm and  $18 < D \leq 30$  mm, respectively

## 6. Bearing Internal Clearance

The internal clearance of a bearing refers to the amount of movement of the inner ring, while the outer ring remains stationary, or vice versa.

Movement in the radial direction reveals a radial internal clearance, while movement in the axial direction shows an axial internal clearance (see Fig. 6.1).

In measuring internal clearances of bearings, a specified measuring load is generally applied to obtain stable measurements.

Accordingly, measurements taken this way are greater than the true clearance due to elastic deformation resulting from the measuring load.

In general, bearing clearances are specified in true clearances.

The amount of internal clearance during operation (known as the running clearance) influences bearing performance-characteristics such as rolling life, heat generation, noise, and vibration.

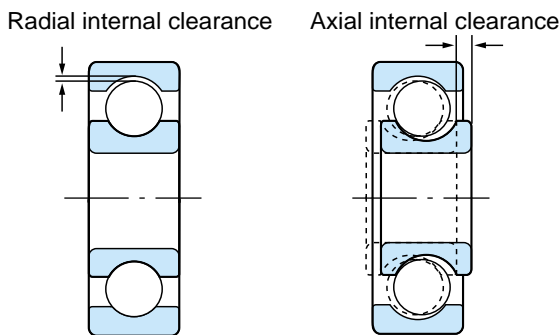

Fig. 6.1 Bearing Internal Clearance

Tables 6.1 and 6.2 show radial internal clearances and selection standards for miniature and extra-small ball bearings.

The axial internal clearance is dependant on the ball size, curvature of raceways, and radial internal clearance.

If the radial internal clearance is constant, the axial internal clearance becomes greater as the ball size and raceway curvature increase.

Figure 6.2 shows an example of the relationship between radial and axial internal clearance.

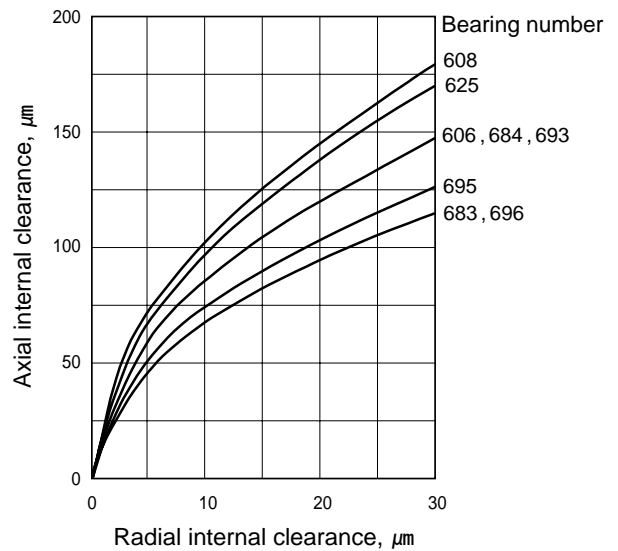

Fig. 6.2 Relationship between Radial and Axial Internal Clearance

Table 6.1 Radial Internal Clearances of Miniature and Extra-small Ball Bearings

Unit  $\mu\text{m}$

Clearance Code	M 1		M 2		M 3		M 4		M 5		M 6	
	min.	max.	min.	max.	min.	max.	min.	max.	min.	max.	min.	max.
Clearance	0	5	3	8	5	10	8	13	13	20	20	28

Remark: To convert to the measured clearances, add the correction value shown below

Measured Load, N	Clearance Correction Value, $\mu\text{m}$					
	M 1	M 2	M 3	M 4	M 5	M 6
2.3	1	1	1	1	1	1

Remark: Miniature ball bearings ... less than 9 mm in outside diameter

Extra-small ball bearings ... 9 mm or more in outside diameter and less than 10 mm in bore diameter

## 6. Bearing Internal Clearance

**Table 6.2 Selection Standards for Radial Internal Clearances of Miniature and Extra-small Ball Bearings**

Application	Bearing Performance Requirements	Clearance Code	Radial Internal Clearance, $\mu\text{m}$	Remark
<b>VTR capstan motors</b> <b>Precision gear instruments</b> <b>Servo mechanism</b> <b>Equipment used at low-speed</b>	<ol style="list-style-type: none"> <li>1. Ensure narrow clearance without clearance adjustment in axial direction</li> <li>2. Frictional torque is not taken into consideration</li> <li>3. Neither durability nor rigidity for axial load is required</li> </ol>	M 1 M 2	0 ~ 8	<ol style="list-style-type: none"> <li>1. Axial loading capacity and axial rigidity are low</li> <li>2. No interference is used for fitting</li> <li>3. For light load and low-speed applications</li> </ol>
<b>Axial flow fan motors</b> <b>Magnetic disc drive spindles</b> <b>Equipment used at low or medium speed and at normal temperatures</b>	<ol style="list-style-type: none"> <li>1. Normal frictional torque is accepted for operation with axial load</li> <li>2. Carry out clearance adjustment in axial direction</li> <li>3. Ordinary durability and rigidity are required for axial load</li> </ol>	M 3 M 4	5 ~ 13	<ol style="list-style-type: none"> <li>1. Adjust internal clearance</li> <li>2. A non-interference fit is used, as a rule</li> <li>3. Use under normal operating load and speed conditions</li> <li>4. Preloading by spring is required at medium speed</li> </ol>
<b>Cleaner motors</b> <b>Magnetic disc pivots</b> <b>Equipment used under high temperature and high-speed conditions</b>	<ol style="list-style-type: none"> <li>1. Under axial load, frictional torque should be reduced</li> <li>2. Carry out clearance adjustment in axial direction</li> <li>3. High durability against radical changes in temperature</li> <li>4. High durability and rigidity are required for axial load</li> </ol>	M 5 M 6	13 ~ 28	<ol style="list-style-type: none"> <li>1. Adjust internal clearance</li> <li>2. Preloading by a spring is required</li> <li>3. Interference fit may be used</li> </ol>



## 7. Preload of Bearings

In general, bearings are used with the proper internal clearance during operation.

Some bearings for small motors are given a negative clearance by applying a preset axial load so as to minimize vibration. This way of using bearings is known as preloading.

### 7.1 Objective of Preload

To improve the positioning accuracy in the radial and axial directions, and to improve the running accuracy, by minimizing runout

To prevent bearing noise caused by vibration and resonance

### 7.2 Methods for Preloading

Preload is applied by fixed-position preloading or constant-pressure preloading. Typical examples of these methods are shown in Table 7.1.

#### [ Comparison between Fixed-position Preloading and Constant-pressure Preloading ]

Given the same preload force, fixed-position preloading produces smaller axial displacement. In other words, high rigidity is readily achieved by fixed-position preloading

In constant-pressure preloading, springs absorb load variations and volume changes of the shaft caused by the temperature differentials between the shaft and housing. Hence the preload force varies little and is stable

With fixed-position preloading a greater preload force can be realized

Consequently, fixed-position preloading is suitable when high rigidity is required. Constant-pressure preloading is appropriate for high-speed applications and the prevention of axial vibrations.

### 7.3 Preload Force

Preload can be applied to prevent noise caused by vibration. If, however, excessive preload is applied to a bearing, unusual heat, an increase in friction, and/or a reduction in fatigue life may result.

Accordingly, the chosen preload force should fall within a range that produces no adverse effect.

In bearings for small motors, a wavy washer is generally used to apply light preload.

A guide to preload forces for miniature and extra-small ball bearings is shown in Table 7.2.

**Table 7.2 Preload Forces for Miniature and Extra-small Ball Bearings**

Preload	Preload Force	Feature
<b>Light preload</b>	1.0 % of $C$ or less	Axial rigidity not required Low torque is important
<b>Medium preload</b>	1.5 % of $C$ or less	Both axial rigidity and low torque are required
<b>Heavy preload</b>	2.0 % of $C$ or less	Axial rigidity is important Rather high torque is acceptable

$C$  : basic dynamic load rating of bearing, kN

**Table 7.1 Methods for Preloading**

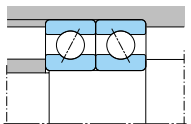
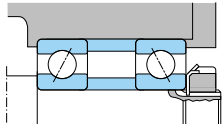
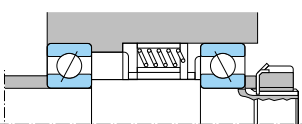
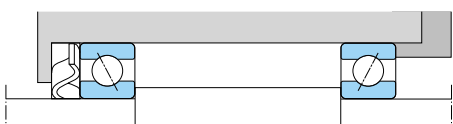
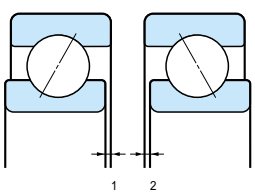
Fixed-position Preloading		Constant-pressure Preloading	
			
A method using duplex bearings in which differences in width are precorrected (as shown below)	A method using a spacer of a precorrected size	A method using a coil spring or conical spring	A method using a wavy washer
			

## 8. Bearing Lubrication

### 8. Bearing Lubrication

#### 8.1 Objective of Lubrication and Methods

Lubrication is critical for bearings. The suitability of a lubricant and lubrication method greatly influences performance and bearing life.

##### [ Functions of Lubrication ]

Lubrication of each part of a bearing reduces friction and wear

Removes heat generated in bearing by friction and other causes

Extends bearing life by constantly forming an appropriate oil film between the rolling contact surfaces

Provides rust prevention and dust proofing

Bearing lubrication methods take advantage of either grease or oil.

Table 8.1 shows a general comparison of these methods.

#### 8.2 Grease Lubrication

In general, shielded and sealed bearings have a suitable quantity of lubricating grease ready packed, so they can be used in their original condition.

Normally, the quantity of sealed grease is approximately 30 % of inner space of the bearing.

If more grease is applied, the bearing torque will increase which may lead to a leakage of grease or an increase in heat.

Therefore, care should be exercised in this regard.

Grease life depends on its ability to resist oxidation and heat the evaporation rate of the base oil. As bearing performance is greatly affected by the brand and type of grease used, consult KOYO prior to selecting a grease.

Table 8.2 shows general-purpose lubricating greases used in miniature and extra-small ball bearings. Lubricating greases developed by KOYO are shown in Table 8.3.

#### 8.3 Oil Lubrication

Oil lubrication is superior to grease lubrication if it is necessary to reduce the starting or running torque to an extremely small value or if the load is very small and the rotation speed is high.

Specifically, if a low torque is required in a low-speed application, bearings are run with a few drops of oil.

For high-temperature and high-speed applications, oil jet or oil mist lubrication is used. Oil mist lubrication is especially effective in high-speed applications.

KOYO's standard lubricating oil is Aero Shell Fluid 12 (MIL- L- 6085A).

**Table 8.1 Comparison of Grease and Oil Lubrication**

Item	Grease	Oil
• Sealing device	Simple	Rather complicated (Care should be taken regarding maintenance)
• Lubrication performance	Good	Excellent
• Rotation speed	Low / medium speed	Suitable also for high speed applications
• Replacement of lubricant	Rather cumbersome	Simple
• Lubricant life	Relatively short	Long
• Cooling effect	None	Good (circulation required)
• Dust filtration	Difficult	Simple

**Table 8.2 General - purpose Lubricating Greases**

Code	Brand	Manufacturer	Thickener	Base Oil	Consistency (after 60 rounds of mixing)	Dropping Point,	Operating Temperature Range,	Application
SR	Multemp SRL	Kyodo Oil	Lithium soap	Ester oil	248	191	- 40 ~ 130	For wide temperature range
AC	Andok C	Esso	Sodium soap	Mineral oil	196	250 min.	0 ~ 130	For low torque
P2	Multemp PS2	Kyodo Oil	Lithium soap	Diester oil Mineral oil	276	198	- 40 ~ 100	For low torque and low temperatures
B5	Beacon 325	Esso	Lithium soap	Diester oil	273	194	- 50 ~ 100	For low torque and low temperatures
4M	SH44M	Dow Corning Toray	Lithium soap	Silicone oil	241	224	- 30 ~ 180	For high temperatures
BJ	Barrierta JFE552	NOK Cruba	Fluorine compound	Fluorine synthetic oil	265	250 min.	- 30 ~ 250	For high temperatures

**Table 8.3 Lubricating Greases Developed by KOYO**

Code	Brand	Thickener	Base Oil	Consistency (after 60 rounds of mixing)	Dropping Point,	Operating Temperature Range,	Application	Application Example
KN	KNG 144	Diurea	Polyalpha olefin Mineral oil	247	250 min.	- 30 ~ 130	For wide temperature range	General-purpose motors, HDD pivots
K7	KNG 170	Diurea	Polyalpha olefin	245	250 min.	- 40 ~ 150	For high speed rotations and high temperatures	General-purpose motors
52	KAM 5	Lithium soap	Ester oil Etheral oil	267	186	- 30 ~ 140	For wide temperature range	General-purpose motors, air conditioner motors
KV	KVA	Lithium soap	Ester oil	332	192	- 40 ~ 100	For low torque and low noise	VTR drum spindles
VC	KVC	Diurea	Polyalpha olefin Ester oil	285	260 min.	- 40 ~ 150	For high speed rotations and high temperatures	Cleaner motors

## 8. Bearing Lubrication

### 8.4 Grease Life of Shielded and Sealed Deep Groove Ball Bearings

Grease life of shielded and sealed deep groove ball bearings in which grease is sealed is estimated by the equation below.

$$\log L = 6.10 - 4.40 \times 10^{-6} d_{mn} - 2.50 \left( \frac{P}{C} - 0.05 \right) - (0.021 - 1.80 \times 10^{-8} d_{mn}) T \dots\dots\dots (8.1)$$

where,

$L$  : grease life, h

$d_m$  :  $\frac{D + d}{2}$ , mm ( $D$  : bearing outside diameter  
 $d$  : bearing bore diameter)

$n$  : rotation speed,  $\text{min}^{-1}$

$P$  : equivalent radial load, N

$C$  : basic dynamic load rating of bearing, N

$T$  : bearing temperature,

To apply Equation (8.1), the conditions below must be met.

**Bearing temperature  $T$**

The equation is applicable when  $50 < T < 120$ .

(If  $T < 50$ , assume that  $T = 50$ )

If  $T > 120$ , consult KOYO.

**Rotation speed  $d_{mn}$**

The equation is applicable when  $12.5 \times 10^4 < d_{mn} < 50 \times 10^4$ .

(If  $d_{mn} < 12.5 \times 10^4$ , use  $d_{mn} = 12.5 \times 10^4$ )

If  $d_{mn} > 50 \times 10^4$ , consult KOYO.

**Load  $\frac{P}{C}$**

The equation is applicable when  $0.05 < \frac{P}{C} < 0.2$ .

(If  $\frac{P}{C} < 0.05$ , consider  $\frac{P}{C} = 0.05$ )

If  $\frac{P}{C} > 0.2$ , consult KOYO.

## 9. Bearing Torque

There are some factors that have considerable influence on the frictional torque of bearings. Such factors include the cage sliding friction, rolling friction caused by load, and the viscous resistance of the lubricant.

It is possible to minimize the cage sliding friction and the rolling friction by means of an appropriate design and a tolerance finishing of the parts.

Bearing torque fluctuates depending on slight variations and waviness in the raceway surfaces as these impair movements of the rolling elements.

The torque also varies according to the viscous resistance of the lubricant, which changes with rotation speed, the quality and quantity of lubricant, and temperature.

The frictional torque of a bearing is classified into starting torque and running torque.

The starting torque is that which is required to overcome the bearing's static friction. The starting torque varies depending on minor differences in tolerance of the raceway surfaces and rolling elements and the position of the rolling elements on the raceway surface immediately before the start.

The running torque refers to the frictional torque of a running bearing. Its magnitude changes with rotation speed, the quality and quantity of lubricant, and atmospheric temperature.

Typical data on running torque are shown in Figs. 9.1 to 9.3.

**Relationship between Rotation Speed and Running Torque**

In general, running torque increases as rotation speed increases (Fig. 9.1).

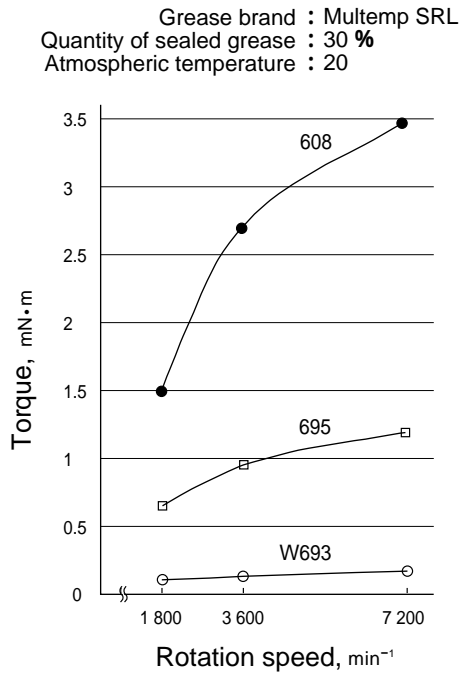

**Fig. 9.1 Relationship between Rotation Speed and Running Torque**

**Relationship between Temperature and Running Torque**

Running torque increases as temperature decreases (Fig. 9.2).

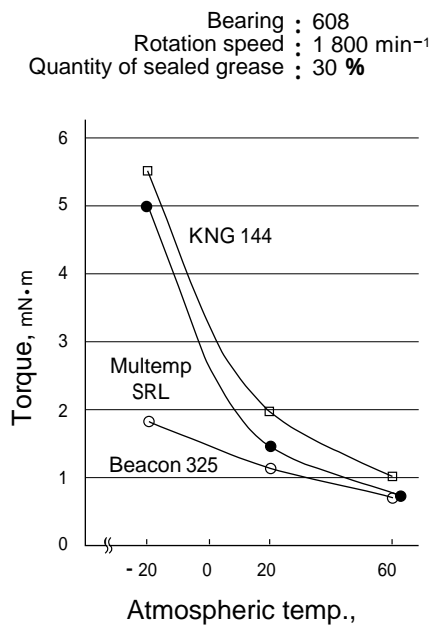

**Fig. 9.2 Relationship between Temperature and Running Torque**

**Relationship between Quantity of Sealed Grease and Running Torque**

Running torque increases as the quantity of sealed grease increases (Fig. 9.3).

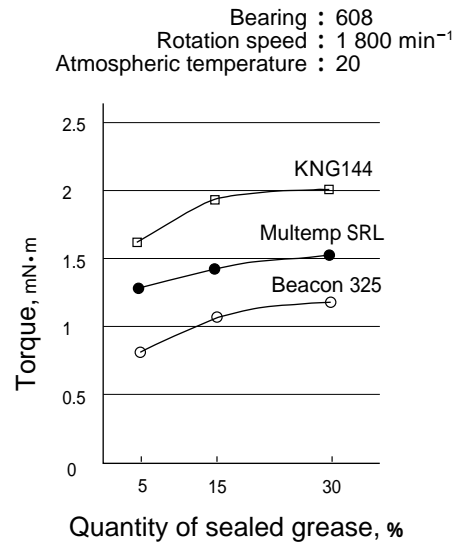

**Fig. 9.3 Relationship between Quantity of Sealed Grease and Running Torque**

## 10. Bearing Materials

### 10. Bearing Materials

Most bearing rings and rolling elements of miniature and extra-small ball bearings are made of high carbon chrome bearing steel. Where bearings need to be corrosion resistant, martensite stainless steel is used.

Materials used for miniature and extra-small ball bearings and their properties are shown in Table 10.1.

Chemical composition of materials used for bearing rings and rolling elements in miniature and extra-small ball bearings are shown in Table 10.2.

**Table 10.1 Materials Used for Miniature and Extra-small Ball Bearings and Their Properties**

Material	Bearing ring / rolling element	High carbon chrome bearing steel		Stainless steel
	Cage	Carbon steel sheet / stainless steel sheet	Reinforced polyamide resin	Stainless steel sheet
	Shield / seal		Nitrile rubber / reinforced polyamide resin	
Property	Operating temperature <sup>1)</sup>	150 max.		300 max.
	Dynamic load rating	High		85 % of bearing steel
	Static load rating	High		80 % of bearing steel
	Frictional torque	Low		Higher than bearing steel
	Application	General / high-tolerance purposes	High-speed applications	Corrosion / heat resistance

Note 1) Actual operating temperature is limited by cage material, seal material, and lubricant.

Table 10.3 shows a guideline for operating temperature ranges in relation to resin cages and resin seals.

If it is necessary to use a lubricant containing a specific additive, consult KOYO

**Table 10.2 Chemical Composition of Materials Used for Bearing Rings and Rolling Elements in Miniature and Extra-small Ball Bearings**

Steel Class	Code	Similar Steel Class	Chemical Composition, %							Bearing Hardness, HRC
			C	Si	Mn	P	S	Cr	Mo	
High carbon chrome bearing steel	JIS SUJ2	SAE 52100	0.95 ~ 1.10	0.15 ~ 0.35	0.50	0.025	0.025	1.30 ~ 1.60	—	60 ~ 64
Stainless steel	JIS SUS440C	SAE 51440C	0.95 ~ 1.20	1.00	1.00	0.04	0.03	16.00 ~ 18.00	0.75	58 ~ 62

For cages and shields, materials such as carbon steel sheets, stainless steel sheets (JIS SUS300 / 400 series), phenol resin, and reinforced polyamide resin are used.

Resin products used for miniature and extra-small ball bearings and their respective operating temperature ranges are shown in Table 10.3.

**Table 10.3 Resin Products used for Miniature and Extra-small Ball Bearings and Their Respective Operating Temperature Ranges**

Resin Product	Code	Operating Temperature Range, Temporary <sup>1)</sup>	
		Continued use	
Resin cage	MG	- 40 ~ 150	- 30 ~ 130
	FG	- 40 ~ 180	- 30 ~ 150
Resin seal	RJ3	- 10 ~ 120	- 10 ~ 100

Note 1) "Temporary" denotes 2 to 3 minutes. Operation at such temperatures should not exceed 30 minutes

## 11. Handling of Bearings

### 11.1 General Precautions for Handling

Since miniature and extra-small ball bearings are made to a higher tolerance than ordinary mechanical parts, one should accordingly handling them with due care.

- 1) Maintain bearings and their vicinity clean
- 2) Handle with care  
A severe shock to a bearing by rough handling may result in flaws, dents, fractures, and chipping.
- 3) Use the correct tools for handling
- 4) Exercise care for the prevention of rust  
Avoid handling them in a highly humid place.  
Wear gloves to prevent body oils from contacting the bearing surface.
- 5) Bearings should be handled by knowledgeable persons
- 6) Work standards for handling bearings should be formulated
  - Storage of bearings
  - Cleansing of bearings and surrounding parts
  - Inspection of dimensions and finish of parts surrounding bearings
  - Mounting
  - Inspection after mounting
  - Maintenance / inspection (regular inspection)

### 11.2 Storage of Bearings

Bearings are shipped after high-quality rust preventive oil is applied to them followed by suitable wrapping. Their quality is guaranteed as long as the wrapping is not damaged.

Bearings, if to be stored for an extended time, should be stored on a shelf at least 30 cm above the floor under conditions of 65 % or less humidity at a temperature of around 20 °C.

Avoid any place that allows direct exposure to the sun or contact with a cool wall.

### 11.3 Mounting Bearings

#### 11.3.1 Precautions for Mounting

##### 1) Preparation

Unwrap bearings just prior to mounting because they are wrapped to prevent rust.

The rust preventive oil applied to bearings offers good lubrication, so bearings for general use or grease-sealed bearings can be used immediately, without cleansing.

For measuring instruments and open type bearings for high-speed applications, remove preventive oil with clean washing oil.

As rust is easily formed on bearings after they are cleansed, do not leave them unattended for long periods.

##### 2) Inspection of Shaft and Housing

Clean the shaft and housing and verify that they are flawless and have no burrs caused by machining.

The inside of the housing should be absolutely free from any residual lapping compound (SiC, Al<sub>2</sub>O<sub>3</sub>, etc.), molding sand, or chips.

Next, ensure that the shaft and housing are fabricated to the dimensions, shapes, and finish as specified on the design drawing.

Measure the shaft diameter and bore diameter of the housing at several positions as shown in Figs. 11.1 and 11.2.

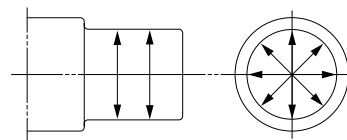

Fig. 11.1 Shaft Diameter Measuring Positions

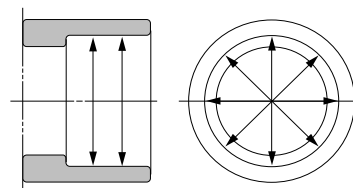

Fig. 11.2 Measuring Positions of Housing Bore Diameter

Additionally, carry out a thorough inspection of the shaft and housing fillet radius and shoulder quareness.

# 11. Handling of Bearings

## 11.3.2 Mounting Bearings

Different methods are used to mount bearings depending on model and fitting conditions. Since, in many cases, the inner ring rotates, an interference fit is used for the inner rings and a clearance fit is used for the outer rings.

If the outer ring is to rotate, an interference fit is used for the outer rings.

Table 11.1 shows methods used to mount bearings with an interference fit.

## 11.4 Trial Run and Inspection

Trial run and inspection are carried out when bearings have been mounted, to check whether the mounting is appropriate.

In the case of small machines, the rotation condition is examined initially by manual operation. After confirmation that no fault exists as noted below, a further inspection is carried out by a powered run.

- Knocking ..... Possible causes are entry of foreign matter, flaw in rolling surfaces, etc
- Excessive torque (heavy) ..... Possible causes are friction in the sealing device, insufficient clearance, mounting errors, etc
- Uneven running ..... Possible causes are defective mounting, mounting errors, etc

**Table 11.1 Press-fitting of Cylindrical Bore Bearings**

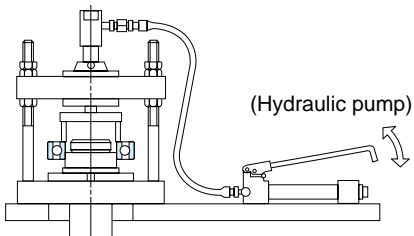
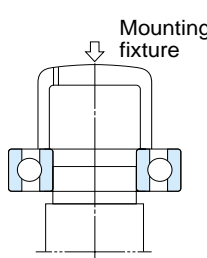
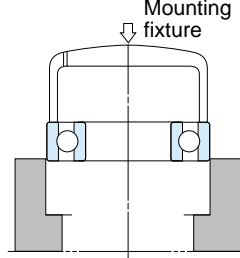
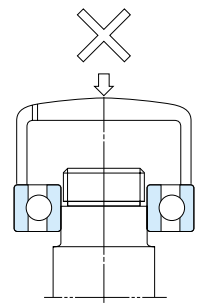
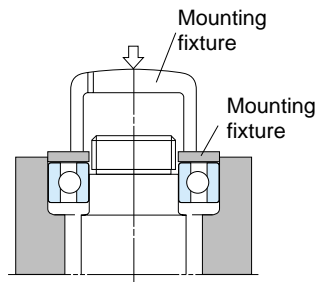
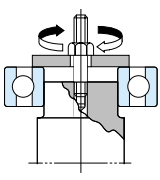
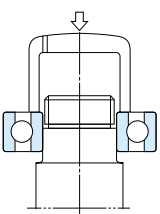
Press-fitting Method	Description
 <p>(a) Use of press (most common)</p>	<p>Whatever method is used, force should be applied to the bearing evenly. For that purpose, use a fixture and fit bearing gently. Do not apply a fixture to the outer ring for press-fitting of the inner ring, or vice versa</p> <div style="display: flex; justify-content: space-around; align-items: center;"> <div style="text-align: center;">  <p>( Press-fitting of inner ring )</p> </div> <div style="text-align: center;">  <p>( Press-fitting of outer ring )</p> </div> <div style="text-align: center;">  <p>( Press-fitting of inner ring )</p> </div> </div> <p>When both inner and outer rings of non-separable bearings require interference, use two kinds of fixtures as shown on the right and press-fit the bearing gently because rolling elements are likely to be damaged. Do not use a hammer in such cases</p> <div style="text-align: center;">  <p>( Simultaneous press-fitting of inner and outer rings )</p> </div>
 <p>(b) Use of nut and bolt</p> <p>{ Threaded hole must be bored in shaft end }</p>	
 <p>(c) Use of hammer</p> <p>{ To be used only when no other method is available }</p>	



### 11.5 Removal of Bearings

Before removing bearings, consider their use after removal.

If bearings are to be disposed of, adopt as effortless a method as possible.

Removing bearings for re-use or to identify causes of failure should be carried out with the same care as at time of mounting to avoid damage.

Specifically, bearings fitted with an interference are likely to be damaged during removal, how to remove bearings should be taken into consideration at the design stage.

It is recommended to design and make an appropriate jig for removal.

Marking the direction and position on the bearing is useful for identifying the causes of failure.

#### Removal Methods

Tables 11.2 and 11.3 show common methods used for removing bearings for re-use or to investigate causes of failure, with interference fits.

**Table 11.2 Removal of Cylindrical Bore Bearings**

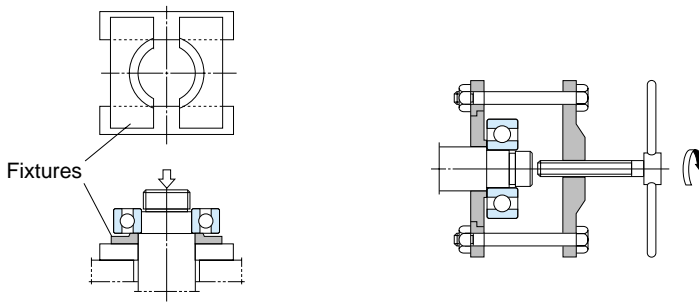
Inner Ring Removal Method	Description
 <p>(a) Removal by press</p> <p>(b) Removal by jig</p>	<p>When removing a non-separable bearing, no external force should be applied to the rolling elements</p> <p>The simplest way is to draw out the bearing with a press as shown in Fig. (a). Provide a fixture to apply the force to the inner ring</p> <p>The method illustrated in Fig. (b) uses a specific removal jig. Ensure that the claws of the jig catch the side face of the inner ring</p>

**Table 11.3 Removal of Outer Ring**

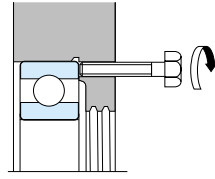
Outer Ring Removal Method	Description
 <p>Bolt holes and bolts for removal</p>	<p>Bolt holes should have been bored in advance and be used to remove an outer ring fitted with interference</p>

## 12. Ceramic Bearings

### 12. Ceramic Bearings

Ceramics (silicon nitride) are suitable for making high-speed and light-weight bearings.

Ceramic bearings have excellent features in that they are highly rigid, heat resistant, and highly corrosion resistant, as well as non-magnetic and non-conductive.

Ceramic miniature and extra-small ball bearings are used in a wide range of advanced technological areas.

For details of ceramic bearings, refer to the KOYO Extreme Special Environment Bearings Catalog (EXSEV bearings), CAT. NO. 208E.

### 12.1 Properties of Ceramics

Table 12.1 shows a comparison between characteristics of ceramics and high carbon chrome bearing steel.

**Table 12.1 Comparison between Characteristics of Ceramics (Si<sub>3</sub>N<sub>4</sub>) and High Carbon Chrome Bearing Steel (SUJ 2)**

Item	Unit	Ceramics (Si <sub>3</sub> N <sub>4</sub> )	Bearing Steel (SUJ 2)	Features and Characteristics of Ceramics
Heat resistance		800	120	Maintains high load capacity at high temperatures
Density	g/cm <sup>3</sup>	3.2	7.8	Reduction in centrifugal force of rolling elements (balls and rollers) Lengthened life and prevention of temperature increase
Coefficient of linear expansion	1/	3.2 × 10 <sup>-6</sup>	12.5 × 10 <sup>-6</sup>	Small changes in internal clearance caused by temperature increase Prevention of vibrations, and small changes in preload force
Vickers' hardness	HV	1 400 ~ 1 700	700 ~ 800	Minor deformation in rolling contact zone High rigidity
Modulus of longitudinal elasticity	GPa	314	206	
Poisson's ratio		0.29	0.3	
Corrosion resistance		Good	No good	Serviceable in special environments such as acid or alkali solutions
Magnetism		Non-magnetic material	Ferromagnetic material	Minor rotation fluctuations caused by magnetic forces in a strong magnetic field
Electrical conductivity		Insulant	Electrical conductor	Prevention of electric pitting (motors etc.)
Bonding form of material		Covalent bond	Metallic bond	Less likely to generate adhesion (transfer) between rolling contacts if oil film diminishes

## 12.2 Features of Ceramic Bearings

### 12.2.1. High rotation speed

Ceramics are lighter than bearing steel. Accordingly, the centrifugal force and sliding caused by gyroscopic moments are reduced in rolling elements rotating at a high speed if they are made of ceramics.

Consequently, ceramics are highly effective in controlling temperature increases.

#### Test bearing

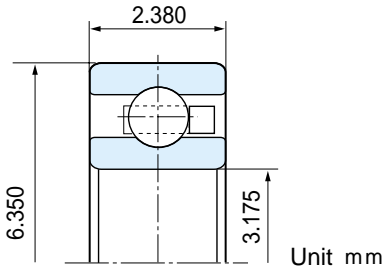

<b>Bearing</b>	3NCOB74ST4M3
<b>Ball</b>	Ceramics (silicon nitride)
<b>Inner and Outer Rings</b>	SUS440C
<b>Cage</b>	Heat-resistant reinforced polyimide resin

#### Performance

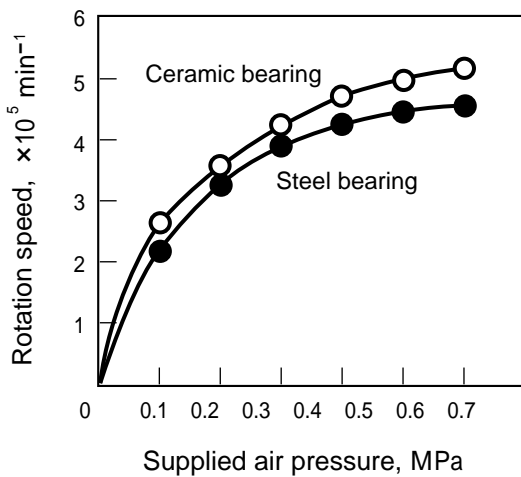

Ceramic bearings are capable of rotating at a 15 % higher speed than steel bearings

### 12.2.2. Long Life

The service life of ceramic bearings is several times longer than that of steel bearings; not only with grease lubrication, but also with oil lubrication.

#### Test bearing

Bearing : 629 ZZL

Rotation speed : 50 000 min<sup>-1</sup> (  $dn$  45 × 10<sup>4</sup> )

Load : axial 108 N

Grease : KNG 170

(Grease fill is 25 % of inner space)

#### Performance

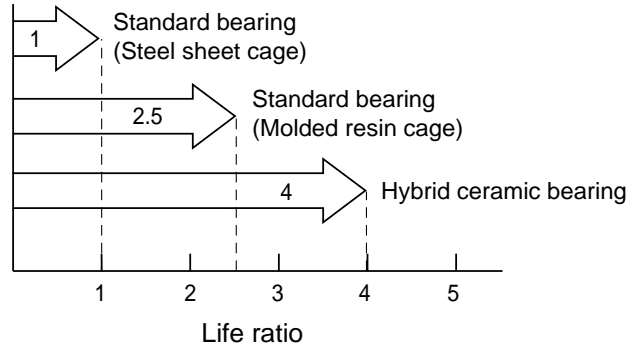

## 12. Ceramic Bearings

### Test method

Test apparatus : thrust tester

Rotation speed :  $1\,400\text{ min}^{-1}$

Load : axial  $1\,176\text{ N}$  (per ball)

Lubricant : class 1 turbine oil (ISO VG56 equivalent)

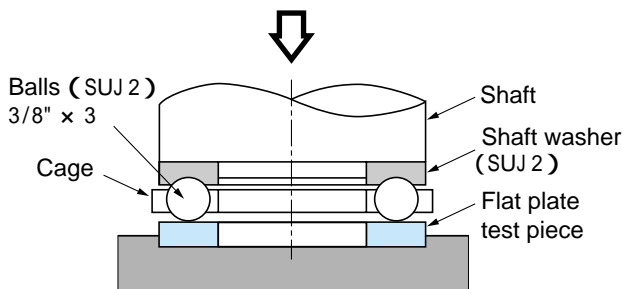

### Performance

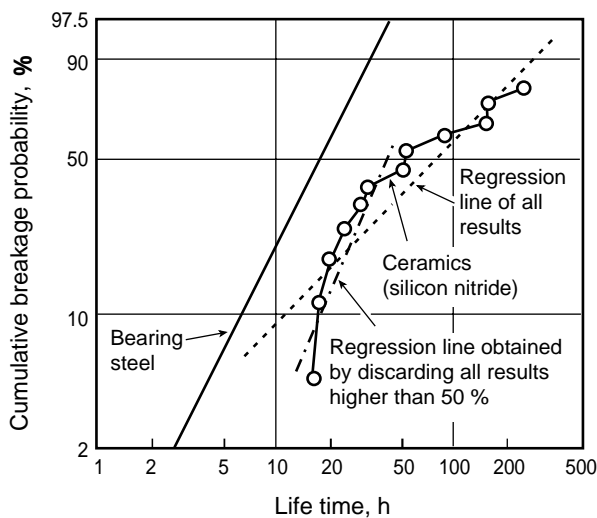

## 12.3 Application Examples of Ceramic Bearings

- Turbochargers
- Spindle motors
- Dental hand pieces
- Polygon scanner motors
- Yarn twisting spindles
- Stepping motors
- Heat rollers
- Semiconductor production facilities
- Vacuum equipment
- Aero space development related equipment

### 12.2.3. Light Weight

The density of ceramics is approximately 40% of bearing steel. Therefore, ceramics are an ideal material for reducing the weight of bearings.

### 12.2.4. Small Dimensional Changes with Respect to Temperature

The coefficient of linear expansion of ceramics is small (25% of bearing steel).

### 12.2.5. High Rigidity

The hardness and the modulus of longitudinal elasticity are greater than that of bearing steel.

### 12.2.6. Insulation

Prevents electric pitting

### 13. Products Information

KOYO is engaged in the manufacture and sales of all types of tolerance miniature and extra-small ball bearings such as open and sealed types as well as those with outer ring flange and locating snap ring.

Our recent developments, which include ceramic bearings and those with resin flanges, are used in a variety of applications.

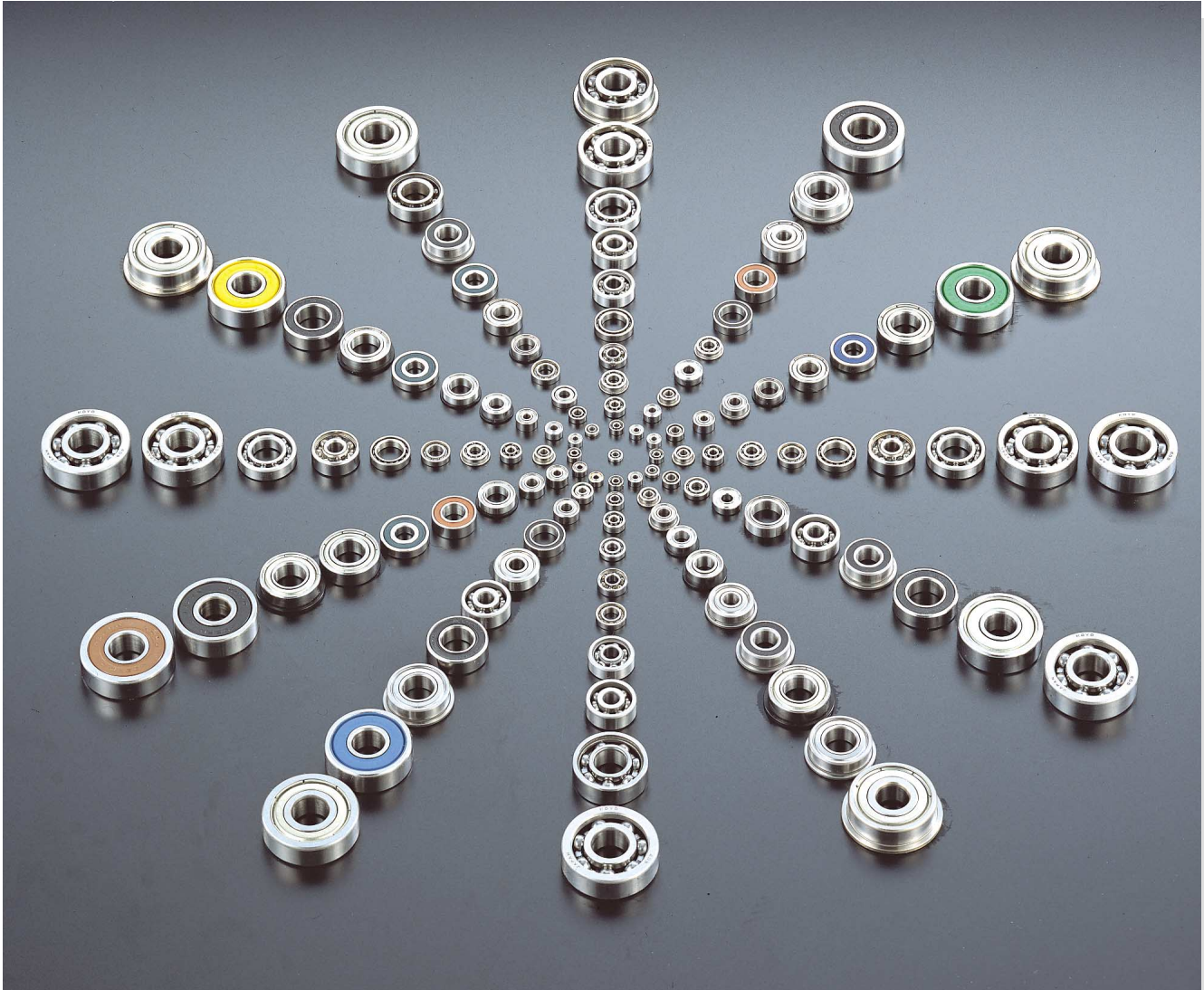

Miniature and Extra-small Ball Bearings



## 13. Products Information



**Ceramic Bearings (EXSEV bearings)**



**FN Bearings  
( Miniature and Extra-small Ball Bearings )  
with Resin Flanges**



**Miniature and Extra-small Ball Bearings  
with Resin Seals**



**Miniature and Extra-small Ball Bearings with Pulleys**



**Small Spindle Units**

We also produce a number of applied products such as bearings with resin or rubber pulleys and small spindle units having built-in bearings.

For additional products, consult KOYO.

## 13. Products Information



**Miniature One-way Clutches**  
( Miniature one-way clutches with resin pulleys or resin gears are also available )



**Miniature Drawn Cup Needle Roller Bearings**



**Miniature Linear Ball Bearings**



## Bearing Dimension Tables CONTENTS

### [ Metric series ]

<b>1. Deep Groove Ball Bearings - Standard series</b>	38
<b>2. Deep Groove Ball Bearings - Thin section series</b>	42
<b>3. Deep Groove Ball Bearings - Narrow-width series</b>	44
<b>4. Deep Groove Ball Bearings with Flanges - Standard series</b>	46
<b>5. Deep Groove Ball Bearings with Flanges - Thin section series</b>	50
<b>6. Deep Groove Ball Bearings with Resin Flanges - FN Bearings</b>	52

### [ Inch series ]

<b>1. Deep Groove Ball Bearings</b>	54
<b>2. Deep Groove Ball Bearings with Flanges</b>	56

Standard series  $d$  1 ~ 5 mm

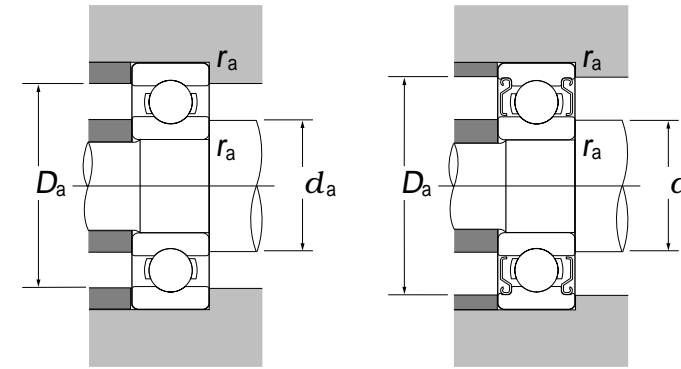
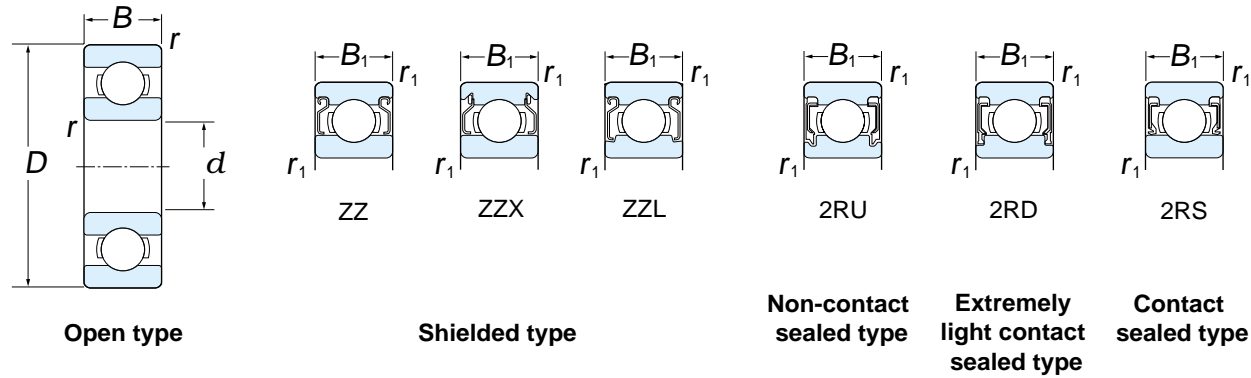

Dynamic equivalent load  $P = XF_r + YF_a$

$\frac{F_a}{C_0}$	$e$	$\frac{F_a}{F_r} \leq e$		$\frac{F_a}{F_r} > e$	
		X	Y	X	Y
0.014 0.028 0.056	0.19 0.22 0.26	1	0	0.56	2.30 1.99 1.71
0.084 0.11 0.17	0.28 0.30 0.34				1.55 1.45 1.31
0.28 0.42 0.56	0.38 0.42 0.44				1.15 1.04 1.00

Static equivalent load  $P_0 = 0.6F_r + 0.5F_a$   
If, however,  $P_0 < F_r$ , assume  $P_0 = F_r$

Full-size Drawing	Boundary dimensions (mm)						Basic load ratings (kN)		Limiting speeds (min <sup>-1</sup> )			Oil lub. (Open type ZX)	Bearing number <sup>1)</sup>			Mounting dimensions (mm)			(Refer.) Mass (g) (Open type)		
	$d$	$D$	$B$	$B_1$	$r$ (min.)	$r_1$ (min.)	Dynamic $C_r$	Static $C_{or}$	Grease lub. (Open type ZZ, 2RU)	(2RD)	(2RS)		Open type	Shielded type	Sealed type	$d_a$ (min.)	$D_a$ (max.)	$r_a$ (max.)			
691 ML1204	1	4	1.6	—	0.1	—	0.14	0.04	120 000	—	—	140 000	691	—	—	—	1.8	3.2	0.1	0.1	
	1.2	4	1.8	—	0.08	—	0.16	0.04	120 000	—	—	140 000	ML1204	—	—	—	1.8	3.4	0.07	0.1	
ML1506 692	1.5	5	2	2.6	0.15	0.15	0.19	0.06	110 000	—	—	130 000	69/1.5	W69/1.5 ZZX	—	—	—	2.7	3.8	0.15	0.1
		6	2.5	3	0.1	0.1	0.33	0.10	86 000	—	—	100 000	ML1506	WML1506 ZZX	—	—	—	2.3	5.2	0.1	0.3
602 ML2508	2	6	2.3	3	0.15	0.1	0.33	0.10	86 000	—	—	100 000	692	W692 ZZ	—	—	—	3.2	4.8	0.1	0.2
		6	2.5	3	0.1	0.1	0.33	0.10	86 000	—	—	100 000	ML2006	WML2006 ZZX	—	—	—	2.8	5.2	0.1	0.3
		7	2.5	3	0.15	0.15	0.39	0.13	67 000	—	—	79 000	ML2007	WML2007 ZZX	—	—	—	3.2	5.8	0.15	0.4
		7	2.8	3.5	0.15	0.15	0.39	0.13	67 000	—	—	79 000	602	W602 ZZX	—	—	—	3.2	5.8	0.15	0.5
ML2508	2.5	7	2.5	3.5	0.15	0.15	0.31	0.11	66 000	—	—	79 000	69/2.5	W69/2.5 ZZ	—	—	—	3.7	5.8	0.15	0.4
		8	2.5	—	0.1	—	0.43	0.15	63 000	—	—	75 000	ML2508/1B	—	—	—	3.3	7.2	0.1	0.6	
		8	2.8	4	0.15	0.1	0.55	0.17	64 000	—	—	76 000	ML2508	WML2508 ZZX	—	—	—	3.7	6.8	0.1	0.6
693 633	3	8	3	4	0.15	0.15	0.55	0.17	64 000	—	—	76 000	693	W693 ZZ	—	—	—	4.2	6.8	0.15	0.6
		9	3	5	0.15	0.15	0.43	0.16	60 000	—	—	72 000	603	W603 ZZX	—	—	—	4.2	7.8	0.15	0.9
		10	4	4	0.15	0.15	0.64	0.23	52 000	—	44 000	63 000	623	623 ZZ	—	—	2RS	4.2	8.8	0.15	1.6
		13	5	5	0.2	0.2	1.30	0.49	44 000	—	—	54 000	633	633 ZZ	—	—	—	4.6	11.4	0.2	3.0
604 625	4	11	4	4	0.15	0.15	0.96	0.35	54 000	—	44 000	65 000	694	694 ZZ	2RU	—	2RS	5.2	9.8	0.15	1.8
		12	4	4	0.2	0.2	0.97	0.36	53 000	—	—	63 000	604	604 ZZ	—	—	—	5.6	10.4	0.2	2.1
		13	5	5	0.2	0.2	1.30	0.49	44 000	—	39 000	54 000	624	624 ZZ	2RU	—	2RS	5.6	11.4	0.2	2.9
		16	5	5	0.3	0.3	1.75	0.67	40 000	—	—	49 000	634	634 ZZ	—	—	—	6	14	0.3	5.3
605 625	5	13	4	4	0.2	0.2	1.10	0.43	50 000	45 000	42 000	60 000	695	695 ZZ	2RU	2RD	2RS	6.6	11.4	0.2	2.2
		14	5	5	0.2	0.2	1.30	0.48	50 000	—	—	60 000	605	605 ZZ	—	—	—	6.6	12.4	0.2	3.5
		16	5	5	0.3	0.3	1.75	0.67	40 000	36 000	33 000	49 000	625	625 ZZ	2RU	2RD	2RS	7	14	0.3	5.0
		19	6	6	0.3	0.3	2.60	1.05	35 000	32 000	27 000	43 000	635	635 ZZ	2RU	2RD	2RS	7	17	0.3	8.5

Note 1) ML1204, ML1506, ML2006, ML2007, ML2508/1B, and ML2508 correspond to former bearing numbers OB05, OB08, OB13, OB14, OB16, and OB17, respectively

Standard series  $d$  6 ~ 9 mm

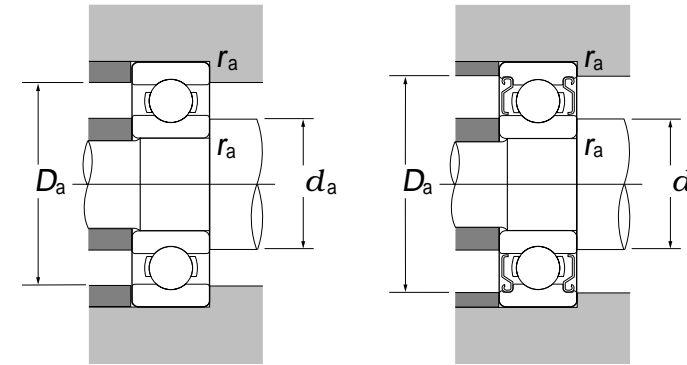
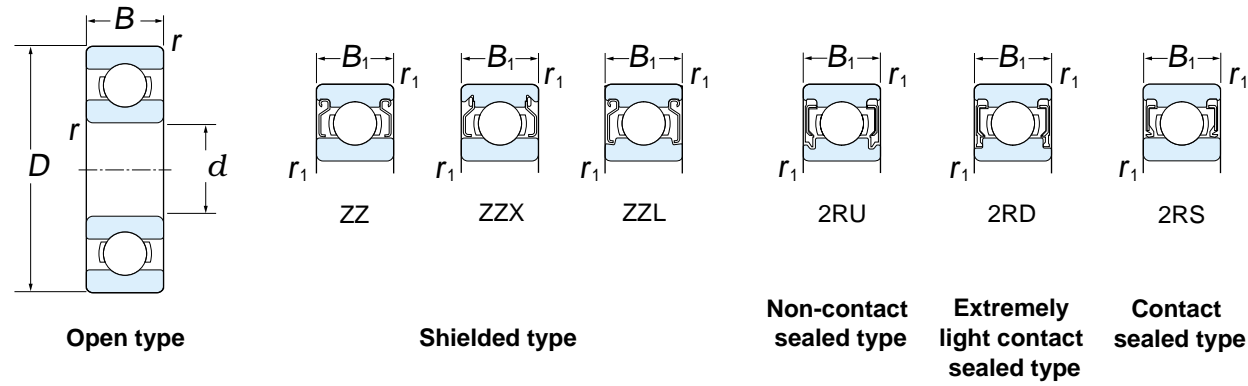

Dynamic equivalent load  $P = XF_r + YF_a$

$\frac{F_a}{C_0}$	$e$	$\frac{F_a}{F_r} \leq e$		$\frac{F_a}{F_r} > e$	
		X	Y	X	Y
0.014 0.028 0.056	0.19 0.22 0.26	1	0	0.56	2.30 1.99 1.71
0.084 0.11 0.17	0.28 0.30 0.34				1.55 1.45 1.31
0.28 0.42 0.56	0.38 0.42 0.44				1.15 1.04 1.00

Static equivalent load  $P_0 = 0.6F_r + 0.5F_a$   
If, however,  $P_0 < F_r$ , assume  $P_0 = F_r$

Full-size Drawing	Boundary dimensions (mm)						Basic load ratings (kN)		Limiting speeds (min <sup>-1</sup> )			Oil lub. (Open type Z)	Bearing number <sup>2)</sup>			Mounting dimensions (mm)			(Refer.) Mass (g) (Open type)
	$d$	$D$	$B$	$B_1$	$r^{(1)}$ (min.)	$r_1^{(1)}$ (min.)	Dynamic $C_r$	Static $C_{or}$	Grease lub.				Open type	Shielded type	Sealed type	$d_a$ (min.)	$D_a$ (max.)	$r_a$ (max.)	
									(Open type ZZ, 2RU)	(2RD)	(2RS)								
696	6	15	5	5	0.2	0.2	1.75	0.67	45 000	41 000	32 000	54 000	696	696 ZZ	2RU 2RD 2RS	7.6	13.4	0.2	3.9
		17	6	6	0.3	0.3	1.95	0.74	43 000	39 000	—	51 000	606	606 ZZ	2RU 2RD —	8	15	0.3	5.8
		19	6	6	0.3	0.3	2.60	1.05	35 000	32 000	27 000	43 000	626	626 ZZ	2RU 2RD 2RS	8	17	0.3	8.1
		19	8	8	0.3	0.3	2.60	1.05	40 000	—	—	47 000	ML6019	ML6019 ZZ	— — —	7	18	0.3	9.0
		22	7	7	0.3	0.3	3.30	1.35	31 000	—	23 000	37 000	636	636 ZZ	— — 2RS	8	20	0.3	13
ML7022	7	17	5	5	0.3	0.3	1.60	0.71	42 000	—	28 000	50 000	697	697 ZZ	— — 2RS	9	15	0.3	5.3
		19	6	6	0.3	0.3	2.60	1.05	40 000	36 000	27 000	47 000	607	607 ZZ	2RU 2RD 2RS	9	17	0.3	7.6
		22	7	7	0.3	0.3	3.30	1.35	31 000	28 000	23 000	37 000	627	627 ZZ	2RU 2RD 2RS	9	20	0.3	13
		22	8	8	0.3	0.3	3.30	1.35	34 000	—	—	41 000	ML7022	ML7022 ZZ	— — —	9	20	0.3	14
698		26	9	9	0.3	0.3	4.55	1.95	26 000	—	—	32 000	637	637 ZZ	— — —	9	24	0.3	24
	8	19	6	6	0.3	0.3	2.25	0.91	39 000	35 000	27 000	46 000	698	698 ZZ	— 2RD 2RS	10	17	0.3	7.2
		22	7	7	0.3	0.3	3.30	1.35	34 000	31 000	23 000	41 000	608	608 ZZ	2RU 2RD 2RS	10	20	0.3	12
		24	8	8	0.3	0.3	3.35	1.40	28 000	—	22 000	35 000	628	628 ZZ	2RU — 2RS	10	22	0.3	18
609		28	9	9	0.3	0.3	4.55	1.95	26 000	23 000	—	32 000	638	638 ZZ	— 2RD —	10	26	0.3	29
	9	20	6	6	0.3	0.3	2.45	1.05	35 000	32 000	25 000	42 000	699	699 ZZ	— 2RD 2RS	11	18	0.3	7.5
		24	7	7	0.3	0.3	3.35	1.40	33 000	30 000	22 000	40 000	609	609 ZZ	2RU 2RD 2RS	11	22	0.3	15
		26	8	8	(0.6)	(0.6)	4.55	1.95	27 000	24 000	19 000	33 000	629	629 ZZ	2RU 2RD 2RS	12.1	22	0.3	20
	30	10	10	0.6	0.6	6.00	2.65	24 000	—	—	29 000	639	639 ZZ	— — —	13	26	0.6	35	

Notes 1) Values in ( ) do not conform to JIS B 1521

2) ML6019 and ML7022 correspond to former bearing numbers OB47 and OB52, respectively

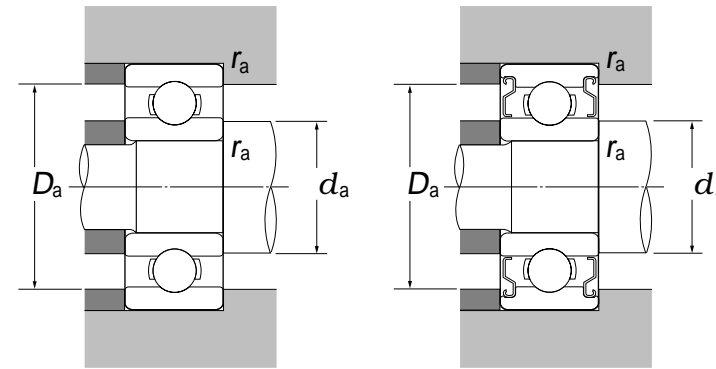
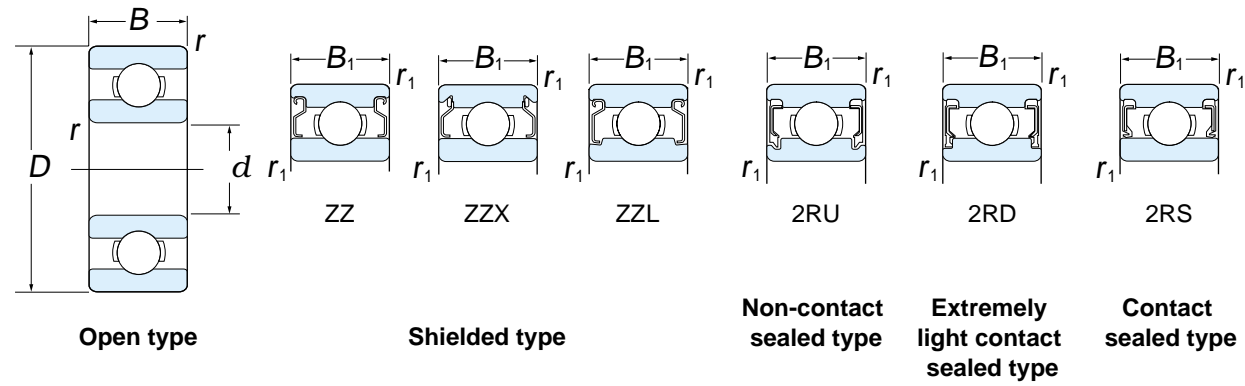

Dynamic equivalent load  $P = XF_r + YF_a$

$\frac{F_a}{C_0}$	$e$	$\frac{F_a}{F_r} \leq e$		$\frac{F_a}{F_r} > e$	
		X	Y	X	Y
0.014 0.028 0.056	0.19 0.22 0.26	1	0	0.56	2.30 1.99 1.71
0.084 0.11 0.17	0.28 0.30 0.34				1.55 1.45 1.31
0.28 0.42 0.56	0.38 0.42 0.44				1.15 1.04 1.00

Static equivalent load  $P_0 = 0.6F_r + 0.5F_a$   
If, however,  $P_0 < F_r$ , assume  $P_0 = F_r$

Full-size Drawing	Boundary dimensions (mm)						Basic load ratings (kN)		Limiting speeds (min <sup>-1</sup> )			Oil lub. (Open type Z)	Bearing number <sup>2)</sup>			Mounting dimensions (mm)			(Refer.) Mass (g) (Open type)		
	$d$	$D$	$B$	$B_1$	$r_1^{(1)}$ (min.)	$r_1^{(1)}$ (min.)	Dynamic $C_r$	Static $C_{or}$	(Open type ZZ, 2RU)	(2RD)	(2RS)		Open type	Shielded type	Sealed type	$d_a$ (min.)	$D_a$ (max.)	$r_a$ (max.)			
681	1	3	1	-	0.07	-	0.10	0.03	130 000	-	-	150 000	681	-	-	-	1.6	2.4	0.05	0.03	
		3	1.5	-	0.08	-	0.08	0.02	130 000	-	-	150 000	ML1003	-	-	-	1.6	2.4	0.07	0.05	
68/1.5	1.5	4	1.2	2	0.1	0.1	0.11	0.03	120 000	-	-	140 000	68/1.5	W68/1.5 ZZ	-	-	-	2.3	3.2	0.1	0.1
		2	5	1.5	2.3	0.1	0.1	0.19	0.06	98 000	-	-	110 000	682	W682 ZZX	-	-	-	2.8	4.4	0.1
682	2	5	2	2.5	0.1	0.08	0.19	0.06	98 000	-	-	110 000	ML2005	WML2005 ZZ	-	-	-	2.6	4.2	0.07	0.1
		5	2	2.5	0.1	0.08	0.19	0.06	98 000	-	-	110 000	ML2005	WML2005 ZZ	-	-	-	2.6	4.2	0.07	0.1
68/2.5	2.5	6	1.8	2.6	0.1	0.1	0.19	0.06	75 000	-	-	89 000	68/2.5	W68/2.5 ZZ	-	-	-	3.3	5.2	0.1	0.2
		3	6	2	2.5	0.08	0.05	0.19	0.06	75 000	-	-	89 000	ML3006	WML3006 ZZ	-	-	-	3.6	5.4	0.05
ML3006	3	7	2	3	(0.15)	(0.15)	0.31	0.11	66 000	-	-	79 000	683	W683 ZZ	-	-	-	4.2	5.8	0.1	0.3
		8	2.5	-	0.1	-	0.43	0.15	63 000	-	-	75 000	ML3008	-	-	-	3.8	7.2	0.1	0.5	
		8	2.5	-	0.1	-	0.43	0.15	63 000	-	-	75 000	ML3008	-	-	-	3.8	7.2	0.1	0.5	
ML4007	4	7	2	2.5	0.08	0.05	0.26	0.11	64 000	-	-	76 000	ML4007	WML4007 ZZ	-	-	-	4.6	6.4	0.05	0.2
		8	2	3	0.1	0.08	0.40	0.14	61 000	-	-	73 000	ML4008	WML4008 ZZ	-	-	-	4.8	7.2	0.08	0.4
		9	2.5	4	(0.15)	(0.15)	0.64	0.23	59 000	-	-	70 000	684	W684 ZZ	-	-	-	5.2	7.8	0.1	0.6
		10	3	4	0.15	0.1	0.65	0.23	56 000	-	-	67 000	ML4010	WML4010 ZZ	-	-	-	5.2	8.8	0.1	1.0
ML4010	5	8	2	2.5	0.08	0.05	0.26	0.12	59 000	-	-	70 000	ML5008	WML5008 ZZ	-	-	-	5.6	7.4	0.05	0.3
		9	2.5	3	0.1	0.08	0.47	0.19	56 000	-	-	67 000	ML5009	WML5009 ZZ	-	-	-	5.8	8.2	0.08	0.5
		10	3	4	0.1	0.1	0.50	0.21	55 000	-	-	65 000	ML5010	WML5010 ZZ	-	-	-	5.8	9	0.1	0.9
		11	3	5	0.15	0.15	0.97	0.36	53 000	-	-	63 000	685	W685 ZZ	-	-	-	6.2	9.8	0.15	1.0
ML5010	6	10	2.5	3	0.1	0.08	0.50	0.22	53 000	-	-	63 000	ML6010	WML6010 ZZ	-	-	-	6.8	9.2	0.08	0.6
		12	3	4	0.15	0.1	0.71	0.29	49 000	-	37 000	59 000	ML6012	WML6012 ZZ	-	-	2RS	7.2	10.8	0.1	1.3
		13	3.5	5	0.15	0.15	1.10	0.44	48 000	43 000	36 000	57 000	686	W686 ZZ	-	2RD	2RS	7.2	11.8	0.15	1.8
ML6010	7	11	2.5	3	0.1	0.08	0.43	0.23	49 000	-	-	59 000	ML7011	WML7011 ZZX	-	-	-	7.8	10.2	0.08	0.7
		13	3	4	0.15	0.15	0.82	0.38	47 000	-	-	55 000	ML7013	WML7013 ZZ	-	-	-	8.2	11.8	0.15	1.4
		14	3.5	5	0.15	0.15	1.15	0.51	45 000	-	-	54 000	687	W687 ZZ	-	-	-	8.2	12.8	0.15	2.0
ML7011	8	12	2.5	3.5	0.1	0.08	0.57	0.30	47 000	-	-	55 000	ML8012	WML8012 ZZ	-	-	-	8.8	11.2	0.08	0.8
		14	3.5	4	0.15	0.15	0.87	0.42	44 000	-	-	52 000	ML8014	WML8014 ZZ	-	-	-	9.2	12.8	0.15	1.8
		16	4	5	0.2	0.2	1.60	0.71	42 000	38 000	28 000	50 000	688	W688 ZZ	2RU	2RD	2RS	9.6	14.4	0.2	3.2
ML8014	9	17	4	5	0.2	0.2	1.35	0.66	39 000	35 000	-	46 000	689	W689 ZZ	2RU	2RD	-	10.6	15.4	0.2	3.5
		17	4	5	0.2	0.2	1.35	0.66	39 000	35 000	-	46 000	689	W689 ZZ	2RU	2RD	-	10.6	15.4	0.2	3.5

Notes 1) Values in ( ) do not conform to JIS B 1521

2) ML1003 and ML2005 correspond to former bearing numbers OB03 and OB11, respectively

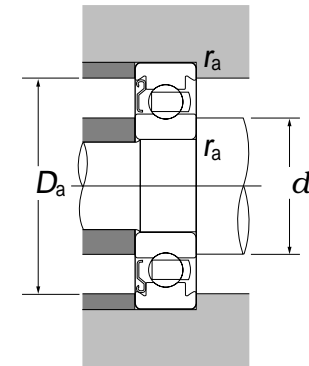
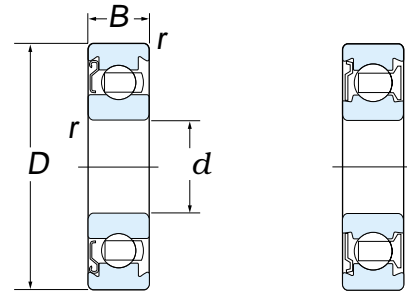

Dynamic equivalent load  $P = XF_r + YF_a$

$\frac{F_a}{C_0}$	$e$	$\frac{F_a}{F_r} \leq e$		$\frac{F_a}{F_r} > e$	
		X	Y	X	Y
0.014 0.028 0.056	0.19 0.22 0.26	1	0	0.56	2.30
					1.99
					1.71
0.084 0.11 0.17	0.28 0.30 0.34				1.55
					1.45
					1.31
0.28 0.42 0.56	0.38 0.42 0.44				1.15 1.04 1.00

Static equivalent load  $P_0 = 0.6F_r + 0.5F_a$   
 If, however,  $P_0 < F_r$ , assume  $P_0 = F_r$

Full-size Drawing	Boundary dimensions (mm)				Basic load ratings (kN)		Limiting speeds (min <sup>-1</sup> )		Bearing number	Mounting dimensions (mm)			(Refer.) Mass (g)
	$d$	$D$	$B$	$r^{(1)}$ (min.)	Dynamic $C_r$	Static $C_{0r}$	Grease lub.	Oil lub.		$d_a$ (min.)	$D_a$ (max.)	$r_a$ (max.)	
ML2005/1BZ	2	5	1.6	0.08	0.19	0.06	98 000	110 000	ML2005/1B Z	2.6	4.2	0.07	0.1
	3	7 8	2 2.6	(0.15) 0.15	0.34 0.55	0.13 0.17	66 000 64 000	79 000 76 000	683 Z 693/1B Z	4.2 4.2	5.8 6.8	0.1 0.15	0.3 0.5
684/1BZ	4	8	2	0.08	0.31	0.11	61 000	73 000	ML4008 Z 684/1B Z 694/1B Z	4.8	7.2	0.08	0.4
		9	2.6	(0.15)	0.64	0.23	59 000	70 000		5.2	7.8	0.1	0.6
		10	3	0.15	0.96	0.35	54 000	65 000		5.2	9.8	0.15	1.8
695/1BZ	5	11	4	0.15	0.71	0.28	53 000	63 000	685/1B Z 695/1B Z	6.2	9.8	0.15	1.0
		13	3	0.2	1.10	0.43	50 000	60 000		6.6	11.4	0.2	2.2
686/1BZ	6	13	3	0.15	1.10	0.44	48 000	57 000	686/1B Z 696/1B Z	7.2	11.8	0.15	1.8
		15	3.5	0.2	1.50	0.60	45 000	54 000		7.6	13.4	0.2	2.8

Note 1) Values in ( ) do not conform to JIS B 1521

Standard series  $d$  1~5 mm

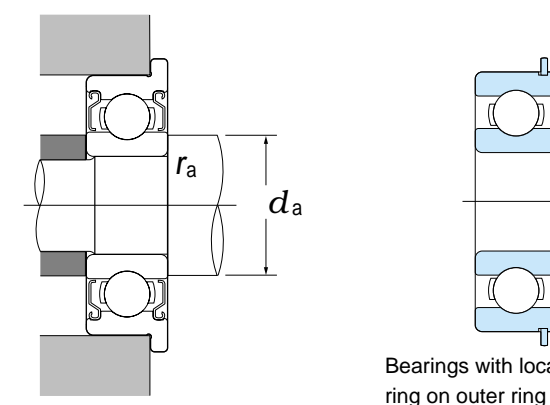
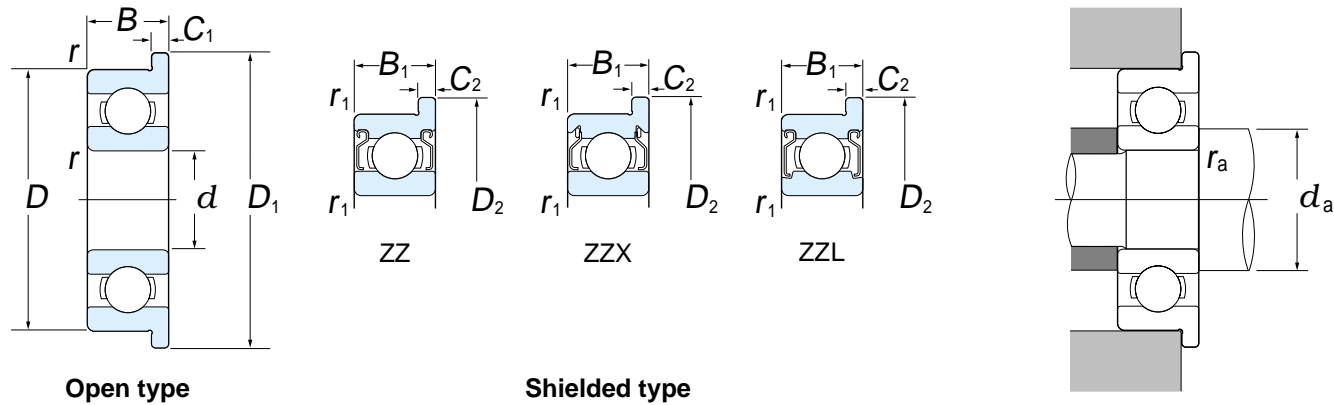

Bearings with locating snap ring on outer ring are also available. Consult KOYO

Dynamic equivalent load  $P = XF_r + YF_a$

$\frac{F_a}{C_0}$	$e$	$\frac{F_a}{F_r} \leq e$		$\frac{F_a}{F_r} > e$	
		X	Y	X	Y
0.014 0.028 0.056	0.19 0.22 0.26	1	0	0.56	2.30 1.99 1.71
0.084 0.11 0.17	0.28 0.30 0.34				1.55 1.45 1.31
0.28 0.42 0.56	0.38 0.42 0.44				1.15 1.04 1.00

Static equivalent load  $P_0 = 0.6F_r + 0.5F_a$   
If, however,  $P_0 < F_r$ , assume  $P_0 = F_r$

Full-size Drawing	Boundary dimensions (mm)						Basic load ratings (kN)		Limiting speeds (min <sup>-1</sup> )		Bearing number <sup>1)</sup>		Flange dimensions (mm)			Mounting dimensions (mm)		(Refer.) Mass (g) (Open type)
	$d$	$D$	$B$	$B_1$	$r$ (min.)	$r_1$ (min.)	Dynamic $C_r$	Static $C_{or}$	Grease lub.	Oil lub.	Open type	Shielded type	$D_1 \cdot D_2$	$C_1$	$C_2$	$d_a$ (min.)	$r_a$ (max.)	
F691	1	4	1.6	—	0.1	—	0.14	0.04	120 000	140 000	F691	—	5	0.5	—	1.8	0.1	0.1
	1.5	5	2	2.6	0.15	0.15	0.17	0.05	110 000	130 000	F69/1.5	WF69/1.5 ZZ	6.5	0.6	0.8	2.7	0.15	0.2
MLF1506	6	2.5	3	0.1	0.1	0.33	0.10	86 000	100 000	MLF1506	WMLF1506 ZZ	7.5	0.6	0.8	2.3	0.1	0.4	
	2	6	2.3	3	0.15	0.1	0.33	0.10	86 000	100 000	F692	WF692 ZZ	7.5	0.6	0.8	3.2	0.1	0.3
F692	6	2.5	3	0.1	0.1	0.33	0.10	86 000	100 000	MLF2006	WMLF2006 ZZ	7.2	0.6	0.6	2.8	0.1	0.4	
	7	2.5	3	0.15	0.15	0.39	0.13	67 000	79 000	MLF2007	WMLF2007 ZZ	8.2	0.6	0.6	3.2	0.15	0.5	
MLF2006	7	2.8	3.5	0.15	0.15	0.39	0.13	67 000	79 000	F602	WF602 ZZ	8.5	0.7	0.9	3.2	0.15	0.6	
	2.5	7	2.5	3.5	0.15	0.15	0.39	0.13	66 000	79 000	F69/2.5	WF69/2.5 ZZX	8.5	0.7	0.9	3.7	0.15	0.5
MLF2508	8	2.5	—	0.1	—	0.55	0.17	64 000	76 000	MLF2508/1B	—	9.2	0.6	—	3.5	0.1	0.7	
	8	2.8	4	0.15	0.1	0.56	0.18	63 000	75 000	MLF2508	WMLF2508 ZZ	9.5	0.7	0.9	3.7	0.1	0.7	
F603	3	8	3	4	0.15	0.15	0.57	0.19	60 000	72 000	F693	WF693 ZZ	9.5	0.7	0.9	4.2	0.15	0.7
	9	3	5	0.15	0.15	0.57	0.19	60 000	72 000	F603	WF603 ZZ	10.5	0.7	1	4.2	0.15	1.0	
F623	10	4	4	0.15	0.15	0.63	0.22	61 000	72 000	F623	F623 ZZ	11.5	1	1	4.2	0.15	1.8	
	13	5	5	0.2	0.2	1.30	0.48	50 000	60 000	F633	F633 ZZ	15	1	1	4.6	0.2	3.4	
F694	4	11	4	4	0.15	0.15	0.96	0.35	54 000	65 000	F694	F694 ZZ	12.5	1	1	5.2	0.15	2.0
	12	4	4	0.2	0.2	0.96	0.35	54 000	65 000	F604	F604 ZZ	13.5	1	1	5.6	0.2	2.3	
F624	13	5	5	0.2	0.2	1.30	0.48	50 000	60 000	F624	F624 ZZ	15	1	1	5.6	0.2	3.3	
	16	5	5	0.3	0.3	1.35	0.52	47 000	55 000	F634	F634 ZZ	18	1	1	6	0.3	5.7	
F625	5	13	4	4	0.2	0.2	1.10	0.43	49 000	59 000	F695	F695 ZZ	15	1	1	6.6	0.2	2.5
	14	5	5	0.2	0.2	1.35	0.51	48 000	57 000	F605	F605 ZZ	16	1	1	6.6	0.2	3.9	
F625	16	5	5	0.3	0.3	1.75	0.67	45 000	54 000	F625	F625 ZZ	18	1	1	7	0.3	5.4	
	19	6	6	0.3	0.3	2.35	0.89	40 000	47 000	F635	F635 ZZ	22	1.5	1.5	7	0.3	9.7	

Note 1) MLF1506, MLF2006, MLF2007, MLF2508/1B, and MLF2508 correspond to former bearing numbers OBF08, OBF13, OBF14, OBF16, and OBF17, respectively



Standard series  $d$  6 ~ 9 mm

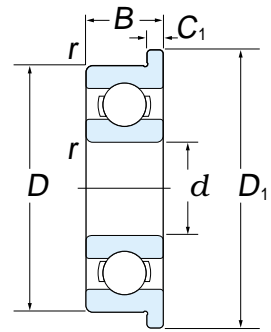

Open type

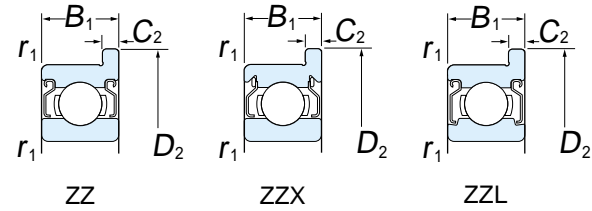

Shielded type

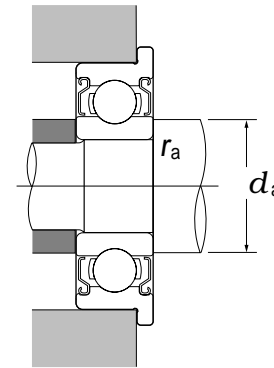
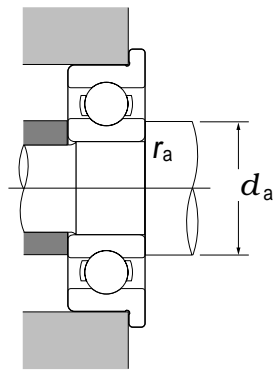

Bearings with locating snap ring on outer ring are also available. Consult KOYO

Dynamic equivalent load  $P = XF_r + YF_a$

$\frac{F_a}{C_0}$	$e$	$\frac{F_a}{F_r} \leq e$		$\frac{F_a}{F_r} > e$	
		X	Y	X	Y
0.014 0.028 0.056	0.19 0.22 0.26	1	0	0.56	2.30 1.99 1.71
0.084 0.11 0.17	0.28 0.30 0.34				1.55 1.45 1.31
0.28 0.42 0.56	0.38 0.42 0.44				1.15 1.04 1.00

Static equivalent load  $P_0 = 0.6F_r + 0.5F_a$   
If, however,  $P_0 < F_r$ , assume  $P_0 = F_r$

Full-size Drawing	Boundary dimensions (mm)						Basic load ratings (kN)		Limiting speeds (min <sup>-1</sup> )		Bearing number		Flange dimensions (mm)			Mounting dimensions (mm)		(Refer.) Mass (g)
	$d$	$D$	$B$	$B_1$	$r$ (min.)	$r_1$ (min.)	Dynamic $C_r$	Static $C_{or}$	Grease lub.	Oil lub.	Open type	Shielded type	$D_1 \cdot D_2$	$C_1$	$C_2$	$d_a$ (min.)	$r_a$ (max.)	
 F696	6	15	5	5	0.2	0.2	1.35	0.52	47 000	55 000	F696	F696 ZZ	17	1.2	1.2	7.6	0.2	4.3
		17	6	6	0.3	0.3	2.25	0.84	43 000	52 000	F606	F606 ZZ	19	1.2	1.2	8	0.3	6.3
		19	6	6	0.3	0.3	2.35	0.89	40 000	47 000	F626	F626 ZZ	22	1.5	1.5	8	0.3	9.2
		22	7	7	0.3	0.3	3.30	1.35	34 000	41 000	F636	F636 ZZ	25	1.5	1.5	8	0.3	14
 F697	7	17	5	5	0.3	0.3	1.60	0.71	42 000	50 000	F697	F697 ZZ	19	1.2	1.2	9	0.3	5.8
		19	6	6	0.3	0.3	2.35	0.89	40 000	47 000	F607	F607 ZZ	22	1.5	1.5	9	0.3	8.7
		22	7	7	0.3	0.3	3.30	1.35	34 000	41 000	F627	F627 ZZ	25	1.5	1.5	9	0.3	14
		26	9	9	0.3	0.3	4.60	1.95	29 000	35 000	F637	F637 ZZ	29	2	2	9	0.3	26
 F609	8	19	6	6	0.3	0.3	2.25	0.91	39 000	46 000	F698	F698 ZZ	22	1.5	1.5	10	0.3	8.3
		22	7	7	0.3	0.3	3.30	1.35	34 000	41 000	F608	F608 ZZ	25	1.5	1.5	10	0.3	13
 F609	9	20	6	6	0.3	0.3	2.45	1.05	37 000	44 000	F699	F699 ZZ	23	1.5	1.5	11	0.3	8.7
		24	7	7	0.3	0.3	3.35	1.45	32 000	38 000	F609	F609 ZZ	27	1.5	1.5	11	0.3	16

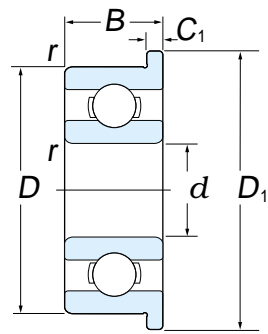

Open type

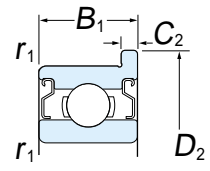

Shielded type

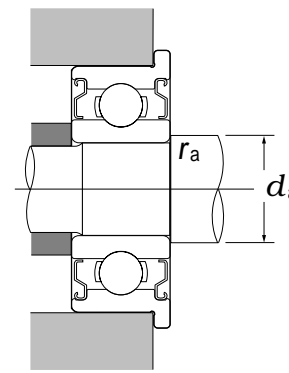
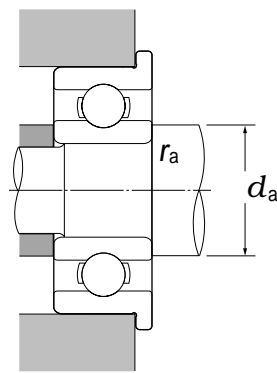
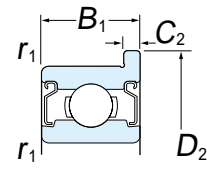
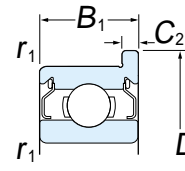

Bearings with locating snap ring on outer ring are also available. Consult KOYO

Dynamic equivalent load  $P = XF_r + YF_a$

$\frac{F_a}{C_0}$	$e$	$\frac{F_a}{F_r} \leq e$		$\frac{F_a}{F_r} > e$	
		X	Y	X	Y
0.014 0.028 0.056	0.19 0.22 0.26	1	0	0.56	2.30 1.99 1.71
0.084 0.11 0.17	0.28 0.30 0.34				1.55 1.45 1.31
0.28 0.42 0.56	0.38 0.42 0.44				1.15 1.04 1.00

Static equivalent load  $P_0 = 0.6F_r + 0.5F_a$   
If, however,  $P_0 < F_r$ , assume  $P_0 = F_r$

Full-size Drawing	Boundary dimensions (mm)						Basic load ratings (kN)		Limiting speeds (min <sup>-1</sup> )		Bearing number <sup>2)</sup>		Flange dimensions (mm)				Mounting dimensions (mm)		(Refer.) Mass (g)
	$d$	$D$	$B$	$B_1$	$r_1^{1)}$ (min.)	$r_1^{1)}$ (min.)	Dynamic $C_r$	Static $C_{or}$	Grease lub.	Oil lub.	Open type	Shielded type	$D_1$	$D_2$	$C_1$	$C_2$	$d_a$ (min.)	$r_a$ (max.)	
F681	1	3	1	-	0.07	-	0.10	0.03	130 000	150 000	F681	-	3.8	-	0.3	-	1.6	0.05	0.03
F68/1.5	1.5	4	1.2	2	0.1	0.1	0.11	0.03	120 000	140 000	F68/1.5	WF68/1.5 ZZ	5	5	0.4	0.6	2.3	0.1	0.1
F682	2	5	1.5	2.3	0.1	0.1	0.17	0.05	99 000	120 000	F682	WF682 ZZ	6.1	6.1	0.5	0.6	2.8	0.1	0.1
F68/2.5	2.5	5	2	2.5	0.1	0.08	0.17	0.05	99 000	120 000	MLF2005	WMLF2005 ZZ	6.2	6.2	0.6	0.6	2.8	0.07	0.2
F682	2.5	6	1.8	2.6	0.1	0.1	0.21	0.07	69 000	82 000	F68/2.5	WF68/2.5 ZZ	7.1	7.1	0.5	0.8	3.3	0.1	0.2
F683	3	6	2	2.5	0.08	0.05	0.21	0.07	69 000	82 000	MLF3006	WMLF3006 ZZ	7.2	7.2	0.6	0.6	3.6	0.05	0.2
F683	7	2	3	(0.15)	(0.15)	-	0.31	0.11	65 000	78 000	F683	WF683 ZZ	8.1	8.1	0.5	0.8	4.2	0.1	0.4
F683	8	2.5	-	0.1	-	-	0.40	0.14	61 000	72 000	MLF3008	-	9.2	-	0.6	-	4.0	0.1	0.6
MLF4008	4	7	2	2.5	0.08	0.05	0.25	0.11	63 000	75 000	MLF4007	WMLF4007 ZZ	8.2	8.2	0.6	0.6	4.6	0.05	0.3
MLF4008	8	2	3	0.1	0.08	0.08	0.40	0.14	61 000	72 000	MLF4008	WMLF4008 ZZ	9.2	9.2	0.6	0.6	4.8	0.08	0.5
MLF4008	9	2.5	4	(0.15)	(0.15)	-	0.64	0.23	59 000	70 000	F684	WF684 ZZ	10.3	10.3	0.6	1	5.2	0.1	0.7
MLF4010	10	3	4	0.15	0.1	-	0.71	0.27	56 000	66 000	MLF4010	WMLF4010 ZZ	11.2	11.6	0.6	0.8	5.2	0.1	1.1
MLF4010	5	8	2	2.5	0.08	0.05	0.22	0.09	59 000	70 000	MLF5008	WMLF5008 ZZ	9.2	9.2	0.6	0.6	5.6	0.05	0.4
MLF4010	9	2.5	3	0.1	0.08	0.08	0.43	0.17	57 000	67 000	MLF5009	WMLF5009 ZZ	10.2	10.2	0.6	0.6	5.8	0.08	0.6
MLF4010	10	3	4	0.1	0.1	0.1	0.43	0.17	57 000	67 000	MLF5010	WMLF5010 ZZ	11.2	11.6	0.6	0.8	5.8	0.1	1.0
F685	11	3	5	0.15	0.15	-	0.71	0.28	53 000	63 000	F685	WF685 ZZ	12.5	12.5	0.8	1	6.2	0.15	1.1
MLF6010	6	10	2.5	3	0.1	0.08	0.50	0.22	53 000	63 000	MLF6010	WMLF6010 ZZ	11.2	11.2	0.6	0.6	6.8	0.08	0.7
MLF6010	12	3	4	0.15	0.1	0.1	0.71	0.29	49 000	59 000	MLF6012	WMLF6012 ZZ	13.2	13.6	0.6	0.8	7.2	0.1	1.4
MLF6010	13	3.5	5	0.15	0.15	-	1.10	0.44	48 000	57 000	F686	WF686 ZZ	15	15	1	1.1	7.2	0.15	2.1
F688	7	11	2.5	3	0.1	0.08	0.46	0.20	49 000	59 000	MLF7011	WMLF7011 ZZ	12.2	12.2	0.6	0.6	7.8	0.08	0.8
F688	13	3	4	0.15	0.15	0.15	0.54	0.28	46 000	55 000	MLF7013	WMLF7013 ZZ	14.2	14.6	0.6	0.8	8.2	0.15	1.5
F688	14	3.5	5	0.15	0.15	-	1.15	0.51	45 000	54 000	F687	WF687 ZZ	16	16	1	1.1	8.2	0.15	2.4
F688	8	12	2.5	3.5	0.1	0.08	0.54	0.27	47 000	55 000	MLF8012	WMLF8012 ZZ	13.2	13.6	0.6	0.8	8.8	0.08	0.9
F688	14	3.5	4	0.15	0.15	0.15	0.87	0.42	44 000	52 000	MLF8014	WMLF8014 ZZ	15.6	15.6	0.8	0.8	9.2	0.15	2.0
F688	16	4	5	0.2	0.2	-	1.25	0.59	42 000	50 000	F688	WF688 ZZ	18	18	1	1.1	9.6	0.2	3.6
F689	9	17	4	5	0.2	0.2	1.35	0.66	39 000	46 000	F689	WF689 ZZ	19	19	1	1.1	10.6	0.2	3.9

Notes 1) Values in ( ) do not conform to JIS B 1521

2) MLF2005 and WMLF2005 ZZ correspond to former bearing numbers OBF11 and WOBF11 ZZ, respectively



**FN Bearings**  $d$  3 ~ 8 mm

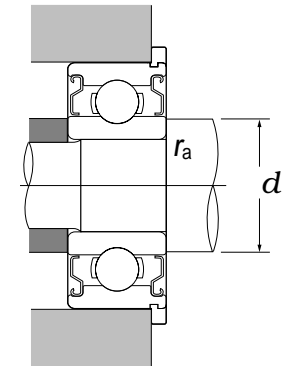
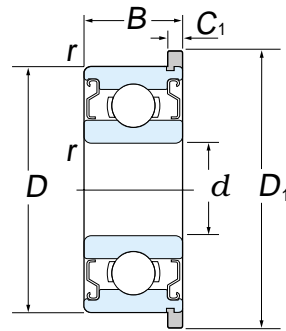

Full-size Drawing	Boundary dimensions (mm)				Basic load ratings (kN)		Limiting speeds (min <sup>-1</sup> ) Grease lub.	Bearing number Shielded type	Flange dimensions (mm)		Mounting dimensions (mm)		(Refer.) Mass (g)
	d	D	B	r (min.)	Dynamic C <sub>r</sub>	Static C <sub>0r</sub>			D <sub>1</sub> <sup>1)</sup>	C <sub>1</sub> <sup>2)</sup>	d <sub>a</sub> (min.)	r <sub>a</sub> (max.)	
 WFN683 WMLFN4008	3	7	3	0.15	0.31	0.11	66 000	WFN683 ZZ	8.1	0.8	4.2	0.1	0.5
		8	4	0.15	0.55	0.17	64 000	WFN693 ZZ	9.5	0.9	4.2	0.15	0.9
 WMLFN5009 WMLFN6010	4	8	3	0.08	0.40	0.13	61 000	WMLFN4008 ZZ	9.2	0.6	4.8	0.08	0.6
		9	4	0.15	0.64	0.23	59 000	WFN684 ZZ	10.3	1	5.2	0.1	1.0
 WMLFN5009 WMLFN6010	5	9	3	0.08	0.38	0.17	56 000	WMLFN5009 ZZ	10.2	0.6	5.8	0.08	0.7
		10	4	0.1	0.50	0.21	55 000	WMLFN5010 ZZ	11.6	0.8	5.8	0.1	1.2
 WMLFN6010 WFN686 ZZ	6	10	3	0.08	0.50	0.22	53 000	WMLFN6010 ZZ	11.2	0.6	6.8	0.08	0.8
		12	4	0.1	0.71	0.29	49 000	WMLFN6012 ZZ	13.6	0.8	7.2	0.1	1.7
		13	5	0.15	1.10	0.44	48 000	WFN686 ZZ	15	1.1	7.2	0.15	2.6
 WMLFN7011 WMLFN8012	7	11	3	0.08	0.43	0.23	49 000	WMLFN7011 ZZ	12.2	0.6	7.8	0.08	0.9
		13	4	0.15	0.82	0.38	47 000	WMLFN7013 ZZ	14.6	0.8	8.2	0.15	2.1
 WMLFN8012 WFN688 ZZ	8	12	3.5	0.08	0.57	0.30	47 000	WMLFN8012 ZZ	13.6	0.8	8.8	0.08	1.1
		14	4	0.15	0.87	0.42	44 000	WMLFN8014 ZZ	15.6	0.8	9.2	0.15	2.1
		16	5	0.2	1.60	0.71	42 000	WFN688 ZZ	18	1.1	9.6	0.2	3.9

Notes 1) The tolerance for D<sub>1</sub> is from +0.125 to -0.050 mm. This does not apply to the portion formed by the molding gate

2) The tolerance for C<sub>1</sub> is from 0 to -0.050 mm

Remark: Consult KOYO for flange dimensions and shapes which are not listed above

Dynamic equivalent load  $P = XF_r + YF_a$

$\frac{F_a}{C_0}$	$e$	$\frac{F_a}{F_r} \leq e$		$\frac{F_a}{F_r} > e$	
		X	Y	X	Y
0.014	0.19	1	0	0.56	2.30
0.028	0.22				1.99
0.056	0.26				1.71
0.084	0.28	1	0	0.56	1.55
0.11	0.30				1.45
0.17	0.34				1.31
0.28	0.38	1	0	0.56	1.15
0.42	0.42				1.04
0.56	0.44				1.00

Static equivalent load  $P_0 = 0.6F_r + 0.5F_a$   
If, however,  $P_0 < F_r$ , assume  $P_0 = F_r$

**Performance**

1. Application Conditions and Environment

Condition / Environment	Operating range	
Resistance to axial load	< 50	65 % or less of C <sub>0</sub>
	50	50 % or less of C <sub>0</sub>
Heat resistance	130 max.	
Low temperature resistance	-30 min.	
Moisture resistance	95 % RH max.	

Remark: C<sub>0</sub> denotes the basic static load rating of bearing

2. Pull-out Strength of Flange

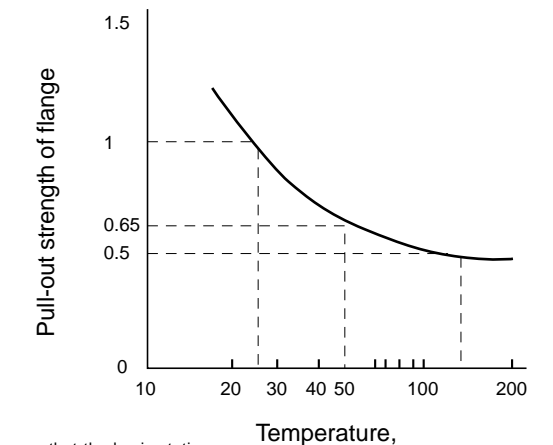

(Assume that the basic static load rating of bearing, C<sub>0</sub>, is 1)

Note: These values for the pull-out strength of the flange are valid when an axial load is applied evenly to the whole circumference of the flange. If the load is applied locally, the pull-out strength may decrease to approximately 10 % of the C<sub>0</sub> value (C<sub>0</sub> denotes the basic static load rating of bearing).

OB and EE series  $d$  1.016 ~ 9.525 mm

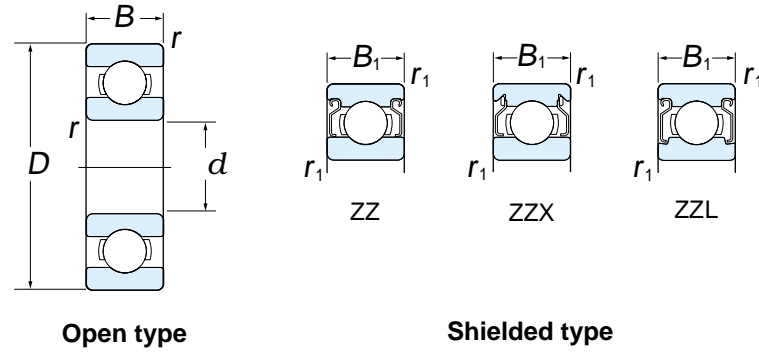

Dynamic equivalent load  $P = XF_r + YF_a$

$\frac{F_a}{C_0}$	$e$	$\frac{F_a}{F_r} \leq e$		$\frac{F_a}{F_r} > e$	
		X	Y	X	Y
0.014 0.028 0.056	0.19 0.22 0.26	1	0	0.56	2.30 1.99 1.71
0.084 0.11 0.17	0.28 0.30 0.34				1.55 1.45 1.31
0.28 0.42 0.56	0.38 0.42 0.44				1.15 1.04 1.00

Static equivalent load  $P_0 = 0.6F_r + 0.5F_a$   
If, however,  $P_0 < F_r$ , assume  $P_0 = F_r$

Full-size Drawing	Boundary dimensions										Basic load ratings (kN)		Limiting speeds (min <sup>-1</sup> )		Bearing number		(Refer.) Mass (g) (Open type)		
	$d$		$D$		$B$		$B_1$		$r$ (min.)		Dynamic $C_r$	Static $C_{Or}$	Grease lub.	Oil lub.	Open type	Shielded type			
	mm	inch	mm	inch	mm	inch	mm	inch	mm	inch									
OB63	1.016	0.0400	3.175	0.1250	1.191	0.0469	—	—	0.08	0.003	0.08	0.02	130 000	150 000	OB63	—	0.05		
OB65	1.191	0.0469	3.967	0.1562	1.588	0.0625	2.380	0.0937	0.08	0.003	0.14	0.04	120 000	140 000	OB65	WOB65 ZZ	0.1		
OB67	1.397	0.0550	4.762	0.1875	1.984	0.0781	2.779	0.1094	0.08	0.003	0.21	0.06	110 000	130 000	OB67	WOB67 ZZ	0.1		
OB69	1.984	0.0781	6.350	0.2500	2.380	0.0937	3.571	0.1406	0.08	0.003	0.33	0.10	86 000	100 000	OB69	WOB69 ZZ	0.3		
OB71	2.380	0.0937	4.762	0.1875	1.588	0.0625	2.380	0.0937	0.08	0.003	0.19	0.06	98 000	110 000	OB71	WOB71 ZZ	0.1		
OB72			7.938	0.3125	2.779	0.1094	3.571	0.1406	0.127	0.005	0.08	0.003	0.55	0.17	64 000	76 000	OB72	WOB72 ZZ	0.6
OB74	3.175	0.1250	6.350	0.2500	2.380	0.0937	2.779	0.1094	0.08	0.003	0.31	0.11	66 000	79 000	OB74	WOB74 ZZ	0.2		
OB75			7.938	0.3125	2.779	0.1094	3.571	0.1406	0.08	0.003	0.43	0.15	63 000	75 000	OB75	WOB75 ZZ	0.6		
OB76			9.525	0.3750	2.779	0.1094	3.571	0.1406	0.127	0.005	0.08	0.003	0.64	0.23	59 000	70 000	OB76	WOB76 ZZ	0.9
EE0	9.525	0.3750	3.967	0.1562	3.967	0.1562	3.967	0.1562	0.3	0.012	0.64	0.23	59 000	70 000	EE0	EE0 ZZ	1.3		
EE1/2			12.700	0.5000	4.366	0.1719	4.366	0.1719	0.3	0.012	0.3	0.012	1.30	0.49	50 000	60 000	EE1/2	EE1/2 ZZ	2.6
OB79	3.967	0.1562	7.938	0.3125	2.779	0.1094	3.175	0.1250	0.08	0.003	0.36	0.15	61 000	73 000	OB79	WOB79 ZZ	0.5		
OB81	4.762	0.1875	7.938	0.3125	2.779	0.1094	3.175	0.1250	0.08	0.003	0.26	0.12	59 000	70 000	OB81	WOB81 ZZ	0.4		
OB82			9.525	0.3750	3.175	0.1250	3.175	0.1250	0.08	0.003	0.08	0.003	0.71	0.27	56 000	66 000	OB82	OB82 ZZ	0.7
EE1			12.700	0.5000	3.967	0.1562	4.978	0.1960	0.3	0.012	0.3	0.012	1.30	0.49	50 000	60 000	EE1	EE1S ZZ	2.1
OB87	6.350	0.2500	9.525	0.3750	3.175	0.1250	3.175	0.1250	0.08	0.003	0.42	0.20	53 000	63 000	OB87	OB87 ZZ	0.5		
OB88			12.700	0.5000	3.175	0.1250	4.762	0.1875	0.127	0.005	0.08	0.003	1.10	0.44	48 000	57 000	OB88	WOB88 ZZ	1.4
EE1 1/2			15.875	0.6250	4.978	0.1960	4.978	0.1960	0.3	0.012	0.3	0.012	1.50	0.62	44 000	52 000	EE1 1/2	EE1 1/2 ZZ	4.3
EE2			19.050	0.7500	5.558	0.2188	7.142	0.2812	0.4	0.016	0.4	0.016	2.80	1.05	40 000	47 000	EE2	EE2S ZZ	7.2
EE3	9.525	0.3750	22.225	0.8750	5.558	0.2188	7.142	0.2812	0.4	0.016	3.35	1.40	33 000	40 000	EE3	EE3S ZZ	9.0		

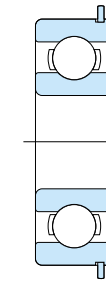
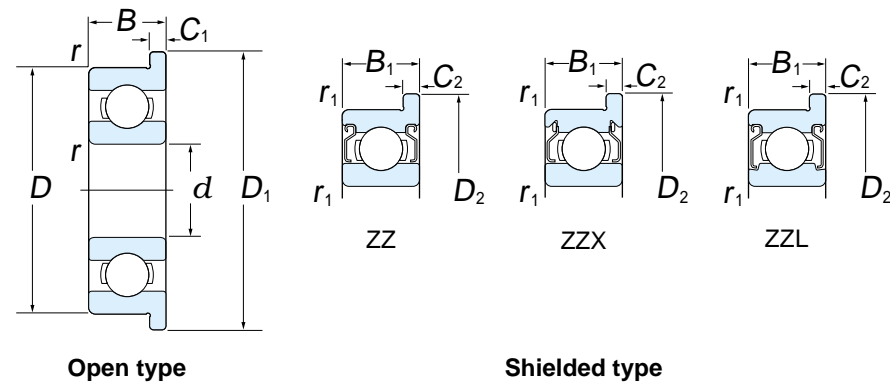

Bearings with locating snap ring on outer ring are also available. Consult KOYO

Dynamic equivalent load  $P = XF_r + YF_a$

$\frac{F_a}{C_0}$	$e$	$\frac{F_a}{F_r} \leq e$		$\frac{F_a}{F_r} > e$	
		X	Y	X	Y
0.014 0.028 0.056	0.19 0.22 0.26	1	0	0.56	2.30 1.99 1.71
0.084 0.11 0.17	0.28 0.30 0.34				1.55 1.45 1.31
0.28 0.42 0.56	0.38 0.42 0.44				1.15 1.04 1.00

Static equivalent load  $P_0 = 0.6F_r + 0.5F_a$   
If, however,  $P_0 < F_r$ , assume  $P_0 = F_r$

Full-size Drawing	Boundary dimensions										Basic load ratings (kN)		Limiting speeds (min <sup>-1</sup> )		Bearing number		Flange dimensions				(Refer.) Mass (g) (Open type)
	$d$ mm inch	$D$ mm inch	$B$ mm inch	$B_1$ mm inch	$r$ (min.) mm inch	$r_1$ (min.) mm inch	Dynamic $C_r$	Static $C_{or}$	Grease lub.	Oil lub.	Open type	Shielded type	$D_1 \cdot D_2$ mm inch	$C_1$ mm inch	$C_2$ mm inch						
OBF65	1.191 0.0469	3.967 0.1562	1.588 0.0625	2.380 0.0937	0.08 0.003	0.08 0.003	0.11	0.03	120 000	140 000	OBF65	WOBF65 ZZ	5.156 0.203	0.330 0.013	0.787 0.031	0.1					
OBF67	1.397 0.0550	4.762 0.1875	1.984 0.0781	2.779 0.1094	0.08 0.003	0.08 0.003	0.23	0.07	110 000	130 000	OBF67	WOBF67 ZZ	5.944 0.234	0.584 0.023	0.787 0.031	0.2					
OBF69	1.984 0.0781	6.350 0.2500	2.380 0.0937	3.571 0.1406	0.08 0.003	0.08 0.003	0.28	0.10	67 000	80 000	OBF69	WOBF69 ZZ	7.518 0.296	0.584 0.023	0.787 0.031	0.4					
OBF71	2.380 0.0937	4.762 0.1875	1.588 0.0625	2.380 0.0937	0.08 0.003	0.08 0.003	0.19	0.06	97 000	110 000	OBF71	WOBF71 ZZ	5.944 0.234	0.457 0.018	0.787 0.031	0.1					
OBF72	3.175 0.1250	7.938 0.3125	2.779 0.1094	3.571 0.1406	0.127 0.005	0.08 0.003	0.55	0.17	64 000	76 000	OBF72	WOBF72 ZZ	9.119 0.359	0.584 0.023	0.787 0.031	0.7					
OBF74		7.938 0.3125	2.779 0.1094	3.571 0.1406	0.08 0.003	0.08 0.003	0.31	0.11	67 000	80 000	OBF74	WOBF74 ZZ	7.518 0.296	0.584 0.023	0.787 0.031	0.3					
OBF75		9.525 0.3750	2.779 0.1094	3.571 0.1406	0.127 0.005	0.08 0.003	0.56	0.18	63 000	75 000	OBF75	WOBF75 ZZ	9.119 0.359	0.584 0.023	0.787 0.031	0.7					
OBF76	9.525 0.3750	3.967 0.1562	3.967 0.1562	0.3 0.012	0.3 0.012	0.64	0.23	59 000	70 000	OBF76	WOBF76 ZZ	10.719 0.422	0.584 0.023	0.787 0.031	1.0						
OBF77		3.967 0.1562	3.175 0.1250	0.08 0.003	0.08 0.003	0.64	0.23	59 000	70 000	OBF77	OBF77 ZZ	11.176 0.440	0.762 0.030	0.762 0.030	1.5						
OBF79	3.967 0.1562	7.938 0.3125	2.779 0.1094	3.175 0.1250	0.08 0.003	0.08 0.003	0.36	0.15	59 000	71 000	OBF79	WOBF79 ZZ	9.119 0.359	0.584 0.023	0.914 0.036	0.6					
OBF84	4.762 0.1875	7.938 0.3125	2.779 0.1094	3.175 0.1250	0.08 0.003	0.08 0.003	0.36	0.15	59 000	71 000	OBF81	WOBF81 ZZ	9.119 0.359	0.584 0.023	0.914 0.036	0.5					
OBF82		9.525 0.3750	3.175 0.1250	3.175 0.1250	0.08 0.003	0.08 0.003	0.71	0.27	56 000	66 000	OBF82	OBF82 ZZ	10.719 0.422	0.584 0.023	0.787 0.031	0.8					
OBF84		12.700 0.5000	4.978 0.1960	4.978 0.1960	0.3 0.012	0.3 0.012	1.30	0.48	50 000	60 000	OBF84	OBF84 ZZ	14.351 0.565	1.067 0.042	1.067 0.042	2.8					
OBF87	6.350 0.2500	9.525 0.3750	3.175 0.1250	3.175 0.1250	0.08 0.003	0.08 0.003	0.37	0.17	53 000	63 000	OBF87	OBF87 ZZ	10.719 0.422	0.584 0.023	0.914 0.036	0.6					
OBF88		12.700 0.5000	3.175 0.1250	4.762 0.1875	0.127 0.005	0.08 0.003	1.10	0.44	48 000	57 000	OBF88	WOBF88 ZZ	13.894 0.547	0.584 0.023	1.143 0.045	1.6					
OBF89		15.875 0.6250	4.978 0.1960	4.978 0.1960	0.3 0.012	0.3 0.012	1.50	0.62	44 000	52 000	OBF89	OBF89 ZZ	17.526 0.690	1.067 0.042	1.067 0.042	5.8					
OBF92	7.938 0.3125	12.700 0.5000	3.967 0.1562	3.967 0.1562	0.127 0.005	0.08 0.003	0.54	0.28	46 000	55 000	OBF92	OBF92 ZZ	13.894 0.547	0.787 0.031	0.787 0.031	1.8					
OBF93	9.525 0.3750	22.225 0.8750	5.558 0.2188	7.142 0.2812	0.4 0.016	0.4 0.016	3.35	1.40	33 000	40 000	OBF93	WOBF93 ZZ	24.613 0.969	1.575 0.062	1.575 0.062	12					

# Supplementary Table 1 Bearing Number Correspondence Table

Supplementary Table 1 (1) Bearing Number Correspondence Table

## (1) Metric Series, Open Type

Bore diameter (mm)	KOYO	NSK	NMB	Bore diameter (mm)	KOYO	NSK	NMB
1	681	681	L-310	6	ML6010	MR106	L-1060
	ML1003	MR31	L-310W51		ML6012	MR126	L-1260
	691	691	R-410		686	686	L-1360
1.2	ML1204	MR41 X	R-412	696	696	R-1560	
1.5	68/1.5	681 X	L-415	606	606	R-1760	
	69/1.5	691 X	R-515	626	626	R-1960	
	ML1506	601 X	R-615	636	636	—	
2	682	682	L-520	7	ML7011	MR117	L-1170
	ML2005	MR52	L-520W02		ML7013	MR137	L-1370
	692	692	R-620		687	687	L-1470
	ML2006	MR62	R-620W52		697	697	—
	ML2007	MR72	R-720Y52		607	607	R-1970
2.5	68/2.5	682 X	L-625	627	627	R-2270	
	69/2.5	692 X	R-725	637	637	—	
	ML2508/1B	MR82 X	R-825Y52	8	ML8012	MR128	L-1280
	ML2508	602 X	R-825		ML8014	MR148	L-1480
3	ML3006	MR63	L-630		688	688	L-1680
	683	683	L-730		698	698	R-1980
	ML3008	MR83	R-830Y52	608	608	R-2280	
4	693	693	R-830	628	628	—	
	603	603	R-930	638	638	—	
	623	623	R-1030	9	689	689	L-1790
	633	633	—		699	699	L-2090
	5	ML4007	MR74		L-740	609	609
ML4008		MR84	L-840		629	629	—
684		684	L-940		639	639	—
5	ML4010	MR104	L-1040	5	ML5008	MR85	L-850
	694	694	R-1140		ML5009	MR95	L-950
	604	604	R-1240		ML5010	MR105	L-1050
	624	624	R-1340		685	685	L-1150
	634	634	R-1640		695	695	R-1350
5	685	685	L-1150	605	605	R-1450	
	695	695	R-1350	625	625	R-1650	
	605	605	R-1450	635	635	R-1950	
	625	625	R-1650				
	635	635	R-1950				

Supplementary Table 1 (2) Bearing Number Correspondence Table

(2) Metric Series, Shielded Type

Bore diameter (mm)	KOYO	NSK	NMB	Bore diameter (mm)	KOYO	NSK	NMB
1.5	W69/1.5 ZZX	691 XZZ	R-515 ZZ	7	WML7011 ZZX	MR117 ZZS	L-1170 ZZ
	WML1506 ZZX	601 XZZS	R-615 ZZ		WML7013 ZZ	MR137 ZZS	L-1370 ZZ
2	W682 ZZX	682 ZZ	L-520 ZZ		W687 ZZ	687 ZZ	L-1470 ZZ
	WML2005 ZZ	MR52 ZZ	L-520 ZZW52		697 ZZ	697 ZZ	—
	W692 ZZ	692 ZZ	R-620 ZZ		607 ZZ	607 ZZ	R-1970 ZZ
	WML2006 ZZX	MR62 ZZS	R-620ZZY52		627 ZZ	627 ZZ	R-2270 ZZ
	WML2007 ZZX	MR72 ZZS	R-720ZZY03		637 ZZ	637 ZZ	—
	W602 ZZX	602 ZZS	R-720 ZZ		8	WML8012 ZZ	MR128 ZZS
2.5	W68/2.5 ZZ	682 XZZS	L-625 ZZ			WML8014 ZZ	MR148 ZZ
	W69/2.5 ZZ	692 XZZ	R-725 ZZ	W688 ZZ		688 ZZ	L-1680 ZZ
	WML2508 ZZX	602 XZZS	R-825 ZZ	698 ZZ		698 ZZ	R-1980 ZZ
3	WML3006 ZZ	MR63 ZZ	L-630 ZZ	608 ZZ		608 ZZ	R-2280 ZZ
	W683 ZZ	683 ZZ	L-730 ZZ	628 ZZ		628 ZZ	—
	W693 ZZ	693 ZZ	R-830 ZZ	638 ZZ	638 ZZ	—	
	623 ZZ	623 ZZ	R-1030 ZZ	9	W689 ZZ	689 ZZ	L-1790 ZZ
	633 ZZ	633 ZZ	—		699 ZZ	699 ZZ	L-2090 ZZ
4	WML4007 ZZ	MR74 ZZS	L-740X2 ZZ		609 ZZ	609 ZZ	—
	WML4008 ZZ	MR84 ZZ	L-840 ZZ		629 ZZ	629 ZZ	—
	W684 ZZ	684 ZZ	L-940 ZZ		639 ZZ	639 ZZ	—
	WML4010 ZZ	MR104 ZZ	L-1040 ZZ	Code of single-shielded type			
	694 ZZ	694 ZZ	R-1140 ZZ	ZX or Z	ZS or Z	Z	
	604 ZZ	604 ZZ	R-1240 ZZ				
5	624 ZZ	624 ZZ	R-1340 ZZ				
	634 ZZ	634 ZZ	R-1640 ZZ				
	WML5008 ZZ	MR85 ZZS	L-850 ZZ				
	WML5009 ZZ	MR95 ZZS	L-950X2 ZZ				
	WML5010 ZZ	MR105 ZZ	L-1050 ZZ				
	W685 ZZ	685 ZZ	L-1150 ZZ				
6	695 ZZ	695 ZZ	R-1350 ZZ				
	605 ZZ	605 ZZ	R-1450 ZZ				
	625 ZZ	625 ZZ	R-1650 ZZ				
	635 ZZ	635 ZZ	R-1950 ZZ				
	WML6010 ZZ	MR106 ZZS	L-1060 ZZ				
	WML6012 ZZ	MR126 ZZ	L-1260 ZZ				
7	W686 ZZ	686 ZZ	L-1360 ZZ				
	696 ZZ	696 ZZ	R-1560 ZZ				
	606 ZZ	606 ZZ	R-1760 ZZ				
	626 ZZ	626 ZZ	R-1960 ZZ				
	636 ZZ	636 ZZ	—				

# Supplementary Table 1 Bearing Number Correspondence Table

Supplementary Table 1 (3) Bearing Number Correspondence Table

## (3) Metric Series, Flanged Type

Bore diameter (mm)	KOYO	NSK	NMB	Bore diameter (mm)	KOYO	NSK	NMB
1	F681	F681	LF-310	6	MLF6010	MF106	LF-1060
	F691	F691	RF-410		MLF6012	MF126	LF-1260
1.5	F68/1.5	F681X	LF-415		F686	F686	LF-1360
	F69/1.5	F691X	RF-515		F696	F696	RF-1560
	MLF1506	F601X	RF-615		F606	F606	RF-1760
2	F682	F682	LF-520		F626	F626	RF-1960
	MLF2005	MF52	—	7	MLF7011	MF117	LF-1170
	F692	F692	RF-620		MLF7013	MF137	LF-1370
	MLF2006	MF62	RF-620W52		F687	F687	LF-1470
	MLF2007	MF72	RF-720Y52		F697	F697	—
F602	F602	RF-720	F607		F607	—	
2.5	F68/2.5	F682X	LF-625	F627	F627	RF-2270	
	F69/2.5	F692X	RF-725	8	MLF8012	MF128	LF-1280
	MLF2508/1B	MF82X	RF-825Y52		MLF8014	MF148	LF-1480
	MLF2508	F602X	RF-825		F688	F688	LF-1680
3	MLF3006	MF63	LF-630		F698	F698	RF-1980
	F683	F683	LF-730	F608	F608	RF-2280	
	MLF3008	MF83	RF-830Y52	9	F689	F689	LF-1790
	F693	F693	RF-830		F699	F699	—
	F603	F603	RF-930		4	MLF4007	MF74
F623	F623	RF-1030	MLF4008			MF84	LF-840
4	F624	F624	RF-1340			F684	F684
	F634	F634	RF-1640	MLF4010		MF104	LF-1040
	5	MLF5008	MF85	LF-850		F694	F694
MLF5009		MF95	LF-950	F604	F604	RF-1240	
MLF5010		MF105	LF-1050	5	F625	F625	RF-1650
F685		F685	LF-1150		F635	F635	RF-1950
F695		F695	RF-1350		5	MLF5008	MF85
F605	F605	RF-1450	MLF5009			MF95	LF-950
F625	F625	RF-1650	MLF5010			MF105	LF-1050
F635	F635	RF-1950	F685	F685		LF-1150	
F695	F695	RF-1350	F695	F695		RF-1350	
F605	F605	RF-1450	F605	F605	RF-1450		
F625	F625	RF-1650	F625	F625	RF-1650		
F635	F635	RF-1950	F635	F635	RF-1950		

Supplementary Table 1 (4) Bearing Number Correspondence Table

(4) Metric Series, Flanged, and Shielded Type

Bore diameter (mm)	KOYO	NSK	NMB	Bore diameter (mm)	KOYO	NSK	NMB
1.5	WF69/1.5 ZZ	F691 XZZ	RF-515 ZZ	7	WMLF7011 ZZX	MF117 ZZS	LF-1170 ZZ
	WMLF1506 ZZ	F601 XZZS	RF-615 ZZ		WMLF7013 ZZ	MF137 ZZS	LF-1370 ZZ
2	WF682 ZZ	F682 ZZ	LF-520 ZZ		WF687 ZZ	F687 ZZ	LF-1470 ZZ
	WMLF2005 ZZ	MF52 ZZS	—		F697 ZZ	F697 ZZ	—
	WF692 ZZ	F692 ZZ	RF-620 ZZ		F607 ZZ	F607 ZZ	—
	WMLF2007 ZZ	MF72 ZZ	RF-720Y03		F627 ZZ	F627 ZZ	RF-2270 ZZ
WF602 ZZ	F602 ZZS	RF-720 ZZ	8	WMLF8012 ZZX	MF128 ZZS	LF-1280 ZZ	
2.5	WF68/2.5 ZZ	F682 XZZS		LF-625 ZZ	WMLF8014 ZZ	MF148 ZZ	LF-1480 ZZ
	WF69/2.5 ZZX	F692 XZZ		RF-725 ZZ	WF688 ZZ	F688 ZZ	LF-1680 ZZ
	WMLF2508 ZZ	F602 XZZS	RF-825 ZZ	F698 ZZ	F698 ZZ	—	
3	WMLF3006 ZZ	MF63 ZZS	LF-630 ZZ	F608 ZZ	F608 ZZ	RF-2280 ZZ	
	WF683 ZZ	F683 ZZ	LF-730 ZZ	9	WF689 ZZ	F689 ZZ	LF-1790 ZZ
	WF693 ZZ	F693 ZZ	RF-830 ZZ		F699 ZZ	F699 ZZ	—
F623 ZZ	F623 ZZ	RF-1030 ZZ	Code of single-shielded type ZX or Z      ZS or Z      Z				
4	WMLF4007 ZZX	MF74 ZZS	LF-740 ZZ	4	WMLF4008 ZZ	MF84 ZZ	LF-840 ZZ
	WMLF4008 ZZ	MF84 ZZ	LF-840 ZZ		WF684 ZZ	F684 ZZ	LF-940 ZZ
	WMLF4010 ZZ	MF104 ZZ	LF-1040 ZZ		F694 ZZ	F694 ZZ	RF-1140 ZZ
	F694 ZZ	F694 ZZ	RF-1140 ZZ		F604 ZZ	F604 ZZ	RF-1240 ZZ
	F604 ZZ	F604 ZZ	RF-1240 ZZ		F624 ZZ	F624 ZZ	RF-1340 ZZ
	F624 ZZ	F624 ZZ	RF-1340 ZZ		F634 ZZ	F634 ZZ	RF-1640 ZZ
5	WMLF5008 ZZX	MF85 ZZS	LF-850 ZZ	5	WMLF5009 ZZX	MF95 ZZS	LF-950 ZZ
	WMLF5009 ZZX	MF95 ZZS	LF-950 ZZ		WMLF5010 ZZ	MF105 ZZ	LF-1050 ZZ
	WMLF5010 ZZ	MF105 ZZ	LF-1050 ZZ		WF685 ZZ	F685 ZZ	LF-1150 ZZ
	WF685 ZZ	F685 ZZ	LF-1150 ZZ		F695 ZZ	F695 ZZ	RF-1350 ZZ
	F695 ZZ	F695 ZZ	RF-1350 ZZ		F605 ZZ	F605 ZZ	RF-1450 ZZ
	F605 ZZ	F605 ZZ	RF-1450 ZZ		F625 ZZ	F625 ZZ	RF-1650 ZZ
F625 ZZ	F625 ZZ	RF-1650 ZZ	F635 ZZ	F635 ZZ	RF-1950 ZZ		
6	WMLF6010 ZZX	MF106 ZZS	LF-1060 ZZ	6	WMLF6012 ZZ	MF126 ZZ	LF-1260 ZZ
	WMLF6012 ZZ	MF126 ZZ	LF-1260 ZZ		WF686 ZZ	F686 ZZ	LF-1360 ZZ
	WF686 ZZ	F686 ZZ	LF-1360 ZZ		F696 ZZ	F696 ZZ	RF-1560 ZZ
	F696 ZZ	F696 ZZ	RF-1560 ZZ		F606 ZZ	F606 ZZ	RF-1760 ZZ
	F606 ZZ	F606 ZZ	RF-1760 ZZ		F626 ZZ	F626 ZZ	—
	F626 ZZ	F626 ZZ	—				



# Supplementary Table 1 Bearing Number Correspondence Table

Supplementary Table 1 (5) Bearing Number Correspondence Table

## (5) Inch Series

Open Type	Bore diameter (mm)	KOYO	NSK	NMB	BARDEN	MPB
	1.016	OB63	R 09	RI-2	–	2 C
	1.191	OB65	R 0	RI-2 <sup>1</sup> / <sub>2</sub>	R 0	2 <sup>1</sup> / <sub>2</sub> C
	1.397	OB67	R 1	RI-3	R 1	3 C
	1.984	OB69	R 1-4	RI-4	R 1-4	4 C
	2.380	OB71 OB72	R 133 R 1-5	RI-3332 RI-5	R 133 R 1-5	3332 C 5 C
	3.175	OB74 OB75 OB76	R 144 R 2-5 R 2-6	RI-418 RI-518 RI-618	R 144 R 2-5 R 2-6	418 C 518 C 618 C
		EE0 EE <sup>1</sup> / <sub>2</sub>	R 2 R 2A	R-2 –	R 2 R 2A	R 2 C R 2A C
	3.967	OB79	R 155	RI-5532	R 155	5532 C
	4.762	OB81 OB82 EE1	R 156 R 166 R 3	RI-5632 RI-6632 R-3	R 156 R 166 R 3	5632 C 6316 C R 3 C
6.350	OB87 OB88 EE <sup>1</sup> / <sub>2</sub>	R 168 R 188 R 4	RI-614 RI-814 R-4	R 168 R 188 R 4	614 C 814 C R 4 C	
	EE2	R 4A	RI-1214	R 4A	R 4AR	
7.938	OB92	R 1810	RI-8516	R 1810	8516 C	
9.525	EE3	R 6	RI-1438	R 6	R 6 R	

Shielded Type	Bore diameter (mm)	KOYO	NSK	NMB	BARDEN	MPB
	1.191	WOB65 ZZ	R 0 ZZS	RI-2 <sup>1</sup> / <sub>2</sub> ZZ	R 0 SS	2 <sup>1</sup> / <sub>2</sub> CHH
	1.397	WOB67 ZZ	R 1 ZZS	RI-3 ZZ	R 1 SS	3 CHH
	1.984	WOB69 ZZ	R 1-4 ZZS	RI-4 ZZ	R 1-4 SS	4 CHH
	2.380	WOB71 ZZ WOB72 ZZ	R 133 ZZS R 1-5 ZZS	RI-3332 ZZ RI-5 ZZ	R 133 SS R 1-5 SS	3332 CHH 5 CHH
	3.175	WOB74 ZZ WOB75 ZZ WOB76 ZZ	R 144 ZZ R 2-5 ZZ R 2-6 ZZS	RI-418 ZZ RI-518 ZZ RI-618 ZZ	R 144 SS R 2-5 SS R 2-6 SS	418 CHH 518 CHH 618 CHH
		EE0 ZZ EE <sup>1</sup> / <sub>2</sub> ZZ	R 2 ZZ R 2A ZZ	R-2 ZZ –	R 2 SS R 2A SS	R 2 CHH R 2A CHH
	3.967	WOB79 ZZ	R 155 ZZS	RI-5532 ZZ	R 155 SS	5532 CHH
	4.762	WOB81 ZZ OB82 ZZ EE1S ZZ	R 156 ZZS R 166 ZZ R 3 ZZ	RI-5632 ZZ RI-6632 ZZ R-3 ZZ	R 156 SS R 166 SS R 3 SS	5632 CHH 6316 CHH R 3 CHH
	6.350	OB87 ZZ WOB88 ZZ EE <sup>1</sup> / <sub>2</sub> ZZ	R 168 ZZS R 188 ZZ R 4 ZZ	RI-614 ZZ RI-814 ZZ R-4 ZZ	R 168 SS R 188 SS R 4 SS	614 CHH 814 CHH R 4 CHH
		EE2S ZZ	R 4A ZZ	RI-1214 ZZ	R 4A SS	R 4A RHH
	7.938	OB92 ZZ	R 1810 ZZS	RI-8516 ZZ	R 1810 SS	8516 CHH
	9.525	EE3S ZZ	R 6 ZZ	RI-1438 ZZ	R 6 SS	R 6 RHH



Supplementary Table 1 (6) Bearing Number Correspondence Table

(6) Inch Series, Flanged Type

Open Type	Bore diameter (mm)	KOYO	NSK	NMB	BARDEN	MPB
	1.191	OBF65	FR 0	RIF-2 <sup>1</sup> / <sub>2</sub>	FR 0	2 <sup>1</sup> / <sub>2</sub> FC
	1.397	OBF67	FR 1	RIF-3	FR 1	3 FC
	1.984	OBF69	FR 1-4	RIF-4	FR 1-4	4 FC
	2.380	OBF71 OBF72	FR 133 FR 1-5	RIF-3332 RIF-5	FR 133 FR 1-5	3332 FC 5 FC
	3.175	OBF74 OBF75 OBF76  OBF77	FR 144 FR 2-5 FR 2-6  FR 2	RIF-418 RIF-518 RIF-618  RF-2	FR 144 FR 2-5 FR 2-6  FR 2	418 FC 518 FC 618 FC  R2 FC
	3.967	OBF79	FR 155	RIF-5532	FR 155	5532 FC
	4.762	OBF81 OBF82 OBF84	FR 156 FR 166 FR 3	RIF-5632 RIF-6632 -	FR 156 FR 166 FR 3	5632 FC 6316 FC -
	6.350	OBF87 OBF88 OBF89	FR 168 FR 188 FR 4	RIF-614 RIF-814 RF-4	FR 168 FR 188 FR 4	614 FC 814 FC R 4 FC
	7.938	OBF92	FR 1810	RIF-8516	FR 1810	8516 FC
9.525	OBF93	FR 6	-	-	-	

Shielded Type	Bore diameter (mm)	KOYO	NSK	NMB	BARDEN	MPB
	1.191	WOBF65 ZZX	FR 0 ZZS	RIF-2 <sup>1</sup> / <sub>2</sub> ZZ	FR 0 SS	2 <sup>1</sup> / <sub>2</sub> FCHH
	1.397	WOBF67 ZZX	FR 1 ZZS	RIF-3 ZZ	FR 1 SS	3 FCHH
	1.984	WOBF69 ZZX	FR 1-4 ZZS	RIF-4 ZZ	FR 1-4 SS	4 FCHH
	2.380	WOBF71 ZZX WOBF72 ZZX	FR 133 ZZS FR 1-5 ZZS	RIF-3332 ZZ RIF-5 ZZ	FR 133 SS FR 1-5 SS	3332 FCHH 5 FCHH
	3.175	WOBF74 ZZX WOBF75 ZZ WOBF76 ZZX  WOBF77 ZZX	FR 144 ZZ FR 2-5 ZZ FR 2-6 ZZS  FR 2 ZZ	RIF-418 ZZ RIF-518 ZZ RIF-618 ZZ  RF-2 ZZ	FR 144 SS FR 2-5 SS FR 2-6 SS  FR 2 SS	418 FCHH 518 FCHH 618 FCHH  R 2 FCHH
	3.967	WOBF79 ZZX	FR 155 ZZS	RIF-5532 ZZ	FR 155 SS	5532 FCHH
	4.762	WOBF81 ZZX WOBF82 ZZX WOBF84 ZZ	FR 156 ZZS FR 166 ZZ FR 3 ZZ	RIF-5632 ZZ RIF-6632 ZZ RF-3 ZZ	FR 156 SS FR 166 SS FR 3 SS	5632 FCHH 6316 FCHH R 3 FCHH
	6.350	WOBF87 ZZX WOBF88 ZZX WOBF89 ZZ	FR 168 ZZS FR 188 ZZ FR 4 ZZ	RIF-614 ZZ RIF-814 ZZ RF-4 ZZ	FR 168 SS FR 188 SS FR 4 SS	614 FCHH 814 FCHH R 4 FCHH
	7.938	OBF92 ZZX	FR 1810 ZZS	RIF-8516 ZZ	FR 1810 SS	8516 FCHH
9.525	WOBF93 ZZ	FR 6 ZZ	RIF-1438 ZZ	FR 6 SS	R 6 FCHH	

Supplementary Table 2 Shaft Tolerances (deviation from nominal dimensions)

Nominal shaft dia. (mm)		Deviation classes of shaft diameter																								Nominal shaft dia. (mm)		Unit μm (Refer.)	$d_{mp}^{(1)}$ of bearing (class 0)					
		over	up to	d 6	e 6	f 6	g 5	g 6	h 5	h 6	h 7	h 8	h 9	h 10	js 5	js 6	js 7	j 5	j 6	k 5	k 6	k 7	m 5	m 6	m 7	n 5	n 6			p 6	r 6	r 7	over	up to
—	3	-20	-14	-6	-2	-2	0	0	0	0	0	0	± 2	± 3	± 5	± 2	+ 4		+ 4	+ 6	+10	+ 6	+ 8	+ 12	+ 8	+ 10	+ 12	+ 16	+ 20	—	3	0	2)	
		-26	-20	-12	-6	-8	-4	-6	-10	-14	-25	-40					-2		0	0	0	+ 2	+ 2	+ 2	+ 4	+ 4	+ 6	+ 10	+ 10			-8		
3	6	-30	-20	-10	-4	-4	0	0	0	0	0	0	± 2.5	± 4	± 6	+ 3	+ 6		+ 6	+ 9	+13	+ 9	+12	+ 16	+ 13	+ 16	+ 20	+ 23	+ 27	3	6	0	8	
		-38	-28	-18	-9	-12	-5	-8	-12	-18	-30	-48				-2	-2		+ 1	+ 1	+ 1	+ 4	+ 4	+ 4	+ 8	+ 8	+ 12	+ 15	+ 15			-8		
6	10	-40	-25	-13	-5	-5	0	0	0	0	0	0	± 3	± 4.5	± 7	+ 4	+ 7		+ 7	+10	+16	+12	+15	+ 21	+16	+ 19	+ 24	+ 28	+ 34	6	10	0	8	
		-49	-34	-22	-11	-14	-6	-9	-15	-22	-36	-58				-2	-2		+ 1	+ 1	+ 1	+ 6	+ 6	+ 6	+10	+10	+ 15	+ 19	+ 19			-8		
10	18	-50	-32	-16	-6	-6	0	0	0	0	0	0	± 4	± 5.5	± 9	+ 5	+ 8		+ 9	+12	+19	+15	+18	+ 25	+20	+ 23	+ 29	+ 34	+ 41	10	18	0	8	
		-61	-43	-27	-14	-17	-8	-11	-18	-27	-43	-70				-3	-3		+ 1	+ 1	+ 1	+ 7	+ 7	+ 7	+12	+12	+ 18	+ 23	+ 23			-8		
18	30	-65	-40	-20	-7	-7	0	0	0	0	0	0	± 4.5	± 6.5	± 10	+ 5	+ 9		+11	+15	+23	+17	+21	+ 29	+24	+ 28	+ 35	+ 41	+ 49	18	30	0	10	
		-78	-53	-33	-16	-20	-9	-13	-21	-33	-52	-84				-4	-4		+ 2	+ 2	+ 2	+ 8	+ 8	+ 8	+15	+15	+ 22	+ 28	+ 28			-10		
30	50	-80	-50	-25	-9	-9	0	0	0	0	0	0	± 5.5	± 8	± 12	+ 6	+11		+13	+18	+27	+20	+25	+ 34	+28	+ 33	+ 42	+ 50	+ 59	30	50	0	12	
		-96	-66	-41	-20	-25	-11	-16	-25	-39	-62	-100				-5	-5		+ 2	+ 2	+ 2	+ 9	+ 9	+ 9	+17	+17	+ 26	+ 34	+ 34			-12		
50	80	-100	-60	-30	-10	-10	0	0	0	0	0	0	± 6.5	± 9.5	± 15	+ 6	+12		+15	+21	+32	+24	+30	+ 41	+33	+ 39	+ 51	+ 60	+ 71	50	65	0	15	
		-119	-79	-49	-23	-29	-13	-19	-30	-46	-74	-120				-7	-7		+ 2	+ 2	+ 2	+11	+11	+ 11	+20	+20	+ 32	+ 41	+ 41			-15		
80	120	-120	-72	-36	-12	-12	0	0	0	0	0	0	± 7.5	± 11	± 17	+ 6	+13		+18	+25	+38	+28	+35	+ 48	+38	+ 45	+ 59	+ 73	+ 86	80	100	0	20	
		-142	-94	-58	-27	-34	-15	-22	-35	-54	-87	-140				-9	-9		+ 3	+ 3	+ 3	+13	+13	+ 13	+23	+23	+ 37	+ 51	+ 51			-20		
120	180	-145	-85	-43	-14	-14	0	0	0	0	0	0	± 9	± 12.5	± 20	+ 7	+14		+21	+28	+43	+33	+40	+ 55	+45	+ 52	+ 68	+ 88	+103	120	140	0	25	
		-170	-110	-68	-32	-39	-18	-25	-40	-63	-100	-160				-11	-11		+ 3	+ 3	+ 3	+15	+15	+ 15	+27	+27	+ 43	+ 65	+ 65			-25		
180	250	-170	-100	-50	-15	-15	0	0	0	0	0	0	± 10	± 14.5	± 23	+ 7	+16		+24	+33	+50	+37	+46	+ 63	+51	+ 60	+ 79	+ 106	+123	180	200	0	30	
		-199	-129	-79	-35	-44	-20	-29	-46	-72	-115	-185				-13	-13		+ 4	+ 4	+ 4	+17	+17	+ 17	+31	+31	+ 50	+ 80	+ 80			-30		
250	315	-190	-110	-56	-17	-17	0	0	0	0	0	0	± 11.5	± 16	± 26	+ 7	+16		+27	+36	+56	+43	+52	+ 72	+57	+ 66	+ 88	+ 126	+146	250	280	0	35	
		-222	-142	-88	-40	-49	-23	-32	-52	-81	-130	-210				-16	-16		+ 4	+ 4	+ 4	+20	+20	+ 20	+34	+34	+ 56	+ 94	+ 94			-35		
315	400	-210	-125	-62	-18	-18	0	0	0	0	0	0	± 12.5	± 18	± 28	+ 7	+18		+29	+40	+61	+46	+57	+ 78	+62	+ 73	+ 98	+ 144	+165	315	355	0	40	
		-246	-161	-98	-43	-54	-25	-36	-57	-89	-140	-230				-18	-18		+ 4	+ 4	+ 4	+21	+21	+ 21	+37	+37	+ 62	+ 108	+108			-40		
400	500	-230	-135	-68	-20	-20	0	0	0	0	0	0	± 13.5	± 20	± 31	+ 7	+20		+32	+45	+68	+50	+63	+ 86	+67	+ 80	+108	+ 166	+189	400	450	0	45	
		-270	-175	-108	-47	-60	-27	-40	-63	-97	-155	-250				-20	-20		+ 5	+ 5	+ 5	+23	+23	+ 23	+40	+40	+ 68	+ 126	+126			-45		
500	630	-260	-145	-76	-	-22	-	0	0	0	0	0	-	± 22	± 35	-	-		-	+44	+70	-	+70	+ 96	-	+ 88	+122	+ 194	+220	500	560	0	50	
		-304	-189	-120	-	-66	-	-44	-70	-110	-175	-280				-	-		0	0	0	+26	+26	+ 26	-	+ 44	+ 78	+ 150	+150			-50		
630	800	-290	-160	-80	-	-24	-	0	0	0	0	0	-	± 25	± 40	-	-		-	+50	+80	-	+80	+110	-	+100	+138	+ 225	+255	630	710	0	75	
		-340	-210	-130	-	-74	-	-50	-80	-125	-200	-320				-	-		0	0	0	+30	+30	+ 30	-	+ 50	+ 88	+ 175	+175			-75		
800	1000	-320	-170	-86	-	-26	-	0	0	0	0	0	-	± 28	± 45	-	-		-	+56	+90	-	+90	+124	-	+112	+156	+ 266	+300	800	900	0	100	
		-376	-226	-142	-	-82	-	-56	-90	-140	-230	-360				-	-		0	0	0	+34	+34	+ 34	-	+ 56	+100	+ 210	+210			-100		
																												+ 276	+310	900	1000			

Notes 1)  $d_{mp}$ : single plane mean bore diameter deviation  
 2) These shall be applied to bearings with a nominal bore diameter 0.6 mm and more

Supplementary Table 3 Housing Bore Tolerances (deviation from nominal dimensions)

Nominal bore dia. (mm)		Deviation classes of housing bore																				Nominal bore dia. (mm)		Unit $\mu\text{m}$	(Refer.)						
over	up to	E 6	F 6	F 7	G 6	G 7	H 6	H 7	H 8	H 9	H 10	J 6	J 7	JS 5	JS 6	JS 7	K 5	K 6	K 7	M 5	M 6	M 7	N 5	N 6	N 7	P 6	P 7	R 7	over	up to	$D_{mp}^{1)}$ of bearing (class 0)
—	3	+20 +14	+12 +6	+16 +6	+8 +2	+12 +2	+6 0	+10 0	+14 0	+25 0	+40 0	+2 -4	+4 -6	$\pm 2$	$\pm 3$	$\pm 5$	0 -4	0 -6	0 -10	-2 -6	-2 -8	-2 -8	-4 -8	-4 -10	-4 -14	-6 -12	-6 -16	-10 -20	—	3	0 <sup>2)</sup> -8
3	6	+28 +20	+18 +10	+22 +10	+12 +4	+16 +4	+8 0	+12 0	+18 0	+30 0	+48 0	+5 -3	$\pm 6$	$\pm 2.5$	$\pm 4$	$\pm 6$	0 -5	+2 -6	+3 -9	-3 -8	-1 -9	0 -12	-7 -12	-5 -13	-4 -16	-9 -17	-8 -20	-8 -23	3	6	0 -8
6	10	+34 +25	+22 +13	+28 +13	+14 +5	+20 +5	+9 0	+15 0	+22 0	+36 0	+58 0	+5 -4	+8 -7	$\pm 3$	$\pm 4.5$	$\pm 7$	+1 -5	+2 -7	+5 -10	-4 -10	-3 -12	0 -15	-8 -14	-7 -16	-4 -19	-12 -21	-9 -24	-13 -28	6	10	0 -8
10	18	+43 +32	+27 +16	+34 +16	+17 +6	+24 +6	+11 0	+18 0	+27 0	+43 0	+70 0	+6 -5	+10 -8	$\pm 4$	$\pm 5.5$	$\pm 9$	+2 -6	+2 -9	+6 -12	-4 -12	-4 -15	0 -18	-9 -17	-9 -20	-5 -23	-15 -26	-11 -29	-16 -34	10	18	0 -8
18	30	+53 +40	+33 +20	+41 +20	+20 +7	+28 +7	+13 0	+21 0	+33 0	+52 0	+84 0	+8 -5	+12 -9	$\pm 4.5$	$\pm 6.5$	$\pm 10$	+1 -8	+2 -11	+6 -15	-5 -14	-4 -17	0 -21	-12 -21	-11 -24	-7 -28	-18 -31	-14 -35	-20 -41	18	30	0 -9
30	50	+66 +50	+41 +25	+50 +25	+25 +9	+34 +9	+16 0	+25 0	+39 0	+62 0	+100 0	+10 -6	+14 -11	$\pm 5.5$	$\pm 8$	$\pm 12$	+2 -9	+3 -13	+7 -18	-5 -16	-4 -20	0 -25	-13 -24	-12 -28	-8 -33	-21 -37	-17 -42	-25 -50	30	50	0 -11
50	80	+79 +60	+49 +30	+60 +30	+29 +10	+40 +10	+19 0	+30 0	+46 0	+74 0	+120 0	+13 -6	+18 -12	$\pm 6.5$	$\pm 9.5$	$\pm 15$	+3 -10	+4 -15	+9 -21	-6 -19	-5 -24	0 -30	-15 -28	-14 -33	-9 -39	-26 -45	-21 -51	-30 -62	50	65	0
																													65	80	-13
80	120	+94 +72	+58 +36	+71 +36	+34 +12	+47 +12	+22 0	+35 0	+54 0	+87 0	+140 0	+16 -6	+22 -13	$\pm 7.5$	$\pm 11$	$\pm 17$	+2 -13	+4 -18	+10 -25	-8 -23	-6 -28	0 -35	-18 -33	-16 -38	-10 -45	-30 -52	-24 -59	-38 -73	80	100	0
																													100	120	-15
120	180	+110 +85	+68 +43	+83 +43	+39 +14	+54 +14	+25 0	+40 0	+63 0	+100 0	+160 0	+18 -7	+26 -14	$\pm 9$	$\pm 12.5$	$\pm 20$	+3 -15	+4 -21	+12 -28	-9 -27	-8 -33	0 -40	-21 -39	-20 -45	-12 -52	-36 -61	-28 -68	-48 -88	120	140	(up to 150) 0
																													140	160	-18
																													160	180	(over 150) 0
180	250	+129 +100	+79 +50	+96 +50	+44 +15	+61 +15	+29 0	+46 0	+72 0	+115 0	+185 0	+22 -7	+30 -16	$\pm 10$	$\pm 14.5$	$\pm 23$	+2 -18	+5 -24	+13 -33	-11 -31	-8 -37	0 -46	-25 -45	-22 -51	-14 -60	-41 -70	-33 -79	-60 -106	180	200	0
																													200	225	-30
																													225	250	0
250	315	+142 +110	+88 +56	+108 +56	+49 +17	+69 +17	+32 0	+52 0	+81 0	+130 0	+210 0	+25 -7	+36 -16	$\pm 11.5$	$\pm 16$	$\pm 26$	+3 -20	+5 -27	+16 -36	-13 -36	-9 -41	0 -52	-27 -50	-25 -57	-14 -66	-47 -79	-36 -88	-74 -126	250	280	0
																													280	315	-35
315	400	+161 +125	+98 +62	+119 +62	+54 +18	+75 +18	+36 0	+57 0	+89 0	+140 0	+230 0	+29 -7	+39 -18	$\pm 12.5$	$\pm 18$	$\pm 28$	+3 -22	+7 -29	+17 -40	-14 -39	-10 -46	0 -57	-30 -55	-26 -62	-16 -73	-51 -87	-41 -98	-87 -144	315	355	0
																													355	400	-40
400	500	+175 +135	+108 +68	+131 +68	+60 +20	+83 +20	+40 0	+63 0	+97 0	+155 0	+250 0	+33 -7	+43 -20	$\pm 13.5$	$\pm 20$	$\pm 31$	+2 -25	+8 -32	+18 -45	-16 -43	-10 -50	0 -63	-33 -60	-27 -67	-17 -80	-55 -95	-45 -108	-103 -166	400	450	0
																													450	500	-45
500	630	+189 +145	+120 +76	+146 +76	+66 +22	+92 +22	+44 0	+70 0	+110 0	+175 0	+280 0	—	—	—	$\pm 22$	$\pm 35$	—	0 -44	0 -70	—	-26 -70	-26 -96	—	-44 -88	-44 -114	-78 -122	-78 -148	-150 -220	500	560	0
																													560	630	-50
630	800	+210 +160	+130 +80	+160 +80	+74 +24	+104 +24	+50 0	+80 0	+125 0	+200 0	+320 0	—	—	—	$\pm 25$	$\pm 40$	—	0 -50	0 -80	—	-30 -80	-30 -110	—	-50 -100	-50 -130	-88 -138	-88 -168	-175 -255	630	710	0
																													710	800	-75
800	1000	+226 +170	+142 +86	+176 +86	+82 +26	+116 +26	+56 0	+90 0	+140 0	+230 0	+360 0	—	—	—	$\pm 28$	$\pm 45$	—	0 -56	0 -90	—	-34 -90	-34 -124	—	-56 -112	-56 -146	-100 -156	-100 -190	-210 -300	800	900	0
																													900	1000	-100
1000	1250	+261 +195	+164 +98	+203 +98	+94 +28	+133 +28	+66 0	+105 0	+165 0	+260 0	+420 0	—	—	—	$\pm 33$	$\pm 52$	—	0 -66	0 -105	—	-40 -106	-40 -145	—	-66 -132	-66 -171	-120 -186	-120 -225	-250 -355	1000	1120	0
																													1120	1250	-125

Notes 1)  $D_{mp}$ : single plane mean outside diameter deviation

2) These shall be applied to bearings with a nominal outside diameter 2.5 mm and more



# Supplementary Table 4 Numerical Values for Standard Tolerance Grades IT

Supplementary Table 4 Numerical Values for Standard Tolerance Grades IT

Basic size (mm)		Standard tolerance grades (IT)																	
		1	2	3	4	5	6	7	8	9	10	11	12	13	14 <sup>1)</sup>	15 <sup>1)</sup>	16 <sup>1)</sup>	17 <sup>1)</sup>	18 <sup>1)</sup>
over	up to	Tolerances (μm)											Tolerances (mm)						
-	3	0.8	1.2	2	3	4	6	10	14	25	40	60	0.10	0.14	0.25	0.40	0.60	1.00	1.40
3	6	1	1.5	2.5	4	5	8	12	18	30	48	75	0.12	0.18	0.30	0.48	0.75	1.20	1.80
6	10	1	1.5	2.5	4	6	9	15	22	36	58	90	0.15	0.22	0.36	0.58	0.90	1.50	2.20
10	18	1.2	2	3	5	8	11	18	27	43	70	110	0.18	0.27	0.43	0.70	1.10	1.80	2.70
18	30	1.5	2.5	4	6	9	13	21	33	52	84	130	0.21	0.33	0.52	0.84	1.30	2.10	3.30
30	50	1.5	2.5	4	7	11	16	25	39	62	100	160	0.25	0.39	0.62	1.00	1.60	2.50	3.90
50	80	2	3	5	8	13	19	30	46	74	120	190	0.30	0.46	0.74	1.20	1.90	3.00	4.60
80	120	2.5	4	6	10	15	22	35	54	87	140	220	0.35	0.54	0.87	1.40	2.20	3.50	5.40
120	180	3.5	5	8	12	18	25	40	63	100	160	250	0.40	0.63	1.00	1.60	2.50	4.00	6.30
180	250	4.5	7	10	14	20	29	46	72	115	185	290	0.46	0.72	1.15	1.85	2.90	4.60	7.20
250	315	6	8	12	16	23	32	52	81	130	210	320	0.52	0.81	1.30	2.10	3.20	5.20	8.10
315	400	7	9	13	18	25	36	57	89	140	230	360	0.57	0.89	1.40	2.30	3.60	5.70	8.90
400	500	8	10	15	20	27	40	63	97	155	250	400	0.63	0.97	1.55	2.50	4.00	6.30	9.70
500	630	-	-	-	-	-	44	70	110	175	280	440	0.70	1.10	1.75	2.80	4.40	7.00	11.00
630	800	-	-	-	-	-	50	80	125	200	320	500	0.80	1.25	2.00	3.20	5.00	8.00	12.50
800	1000	-	-	-	-	-	56	90	140	230	360	560	0.90	1.40	2.30	3.60	5.60	9.00	14.00
1000	1250	-	-	-	-	-	66	105	165	260	420	660	1.05	1.65	2.60	4.20	6.60	10.50	16.50
1250	1600	-	-	-	-	-	78	125	195	310	500	780	1.25	1.95	3.10	5.00	7.80	12.50	19.50
1600	2000	-	-	-	-	-	92	150	230	370	600	920	1.50	2.30	3.70	6.00	9.20	15.00	23.00
2000	2500	-	-	-	-	-	110	175	280	440	700	1100	1.75	2.80	4.40	7.00	11.00	17.50	28.00
2500	3150	-	-	-	-	-	135	210	330	540	860	1350	2.10	3.30	5.40	8.60	13.50	21.00	33.00

(Note) 1) Standard tolerance grades IT 14 to IT 18 (incl.) shall not be used for basic sizes less than or equal to 1 mm

Supplementary Table 5 Prefixes used with SI Units

Factor	Prefix		Factor	Prefix	
	Name	Symbol		Name	Symbol
10 <sup>18</sup>	exa	E	10 <sup>-1</sup>	deci	d
10 <sup>15</sup>	peta	P	10 <sup>-2</sup>	centi	c
10 <sup>12</sup>	tera	T	10 <sup>-3</sup>	milli	m
10 <sup>9</sup>	giga	G	10 <sup>-6</sup>	micro	μ
10 <sup>6</sup>	mega	M	10 <sup>-9</sup>	nano	n
10 <sup>3</sup>	kilo	k	10 <sup>-12</sup>	pico	p
10 <sup>2</sup>	hecto	h	10 <sup>-15</sup>	femto	f
10	deka	da	10 <sup>-18</sup>	atto	a

Supplementary Table 6 (1) SI Units and Conversion Factors

Mass	SI units	Other units <sup>1)</sup>	Conversion into SI units	Conversion from SI units
Angle	rad [radian(s)]	° [degree(s)] ※ ' [minute(s)] ※ " [second(s)] ※	1° = π/180 rad 1' = π/10 800 rad 1" = π/64 800 rad	1 rad = 57.295 78°
Length	m [meter(s)]	Å [Angstrom unit] ※※ μ [micron(s)] in [inch(es)] ft [foot (feet)] yd [yard(s)] mile [mile(s)]	1 Å = 10 <sup>-10</sup> m = 0.1 nm = 100 pm 1 μ = 1 μm 1 in = 25.4 mm 1 ft = 12 in = 0.304 8 m 1 yd = 3 ft = 0.914 4 m 1 mile = 5 280 ft = 1 609.344 m	1 m = 10 <sup>10</sup> Å 1 m = 39.37 in 1 m = 3.280 8 ft 1 m = 1.093 6 yd 1 km = 0.621 4 mile
Area	m <sup>2</sup> [square meter(s)]	a [are(s)] ha [hectare(s)] acre [acre(s)]	1 a = 100 m <sup>2</sup> 1 ha = 10 <sup>4</sup> m <sup>2</sup> 1 acre = 4 840 yd <sup>2</sup> = 4 046.86 m <sup>2</sup>	1 km <sup>2</sup> = 247.1 acre
Volume	m <sup>3</sup> [cubic meter(s)]	ℓ, L [liter(s)] cc [cubic centimeters] gal (US) [gallon(s)] floz (US) [fluid ounce(s)] barrel (US) [barrels (US)]	1 ℓ = 1 dm <sup>3</sup> = 10 <sup>-3</sup> m <sup>3</sup> 1 cc = 1 cm <sup>3</sup> = 10 <sup>-6</sup> m <sup>3</sup> 1 gal (US) = 231 in <sup>3</sup> = 3.785 41 dm <sup>3</sup> 1 floz (US) = 29.573 5 cm <sup>3</sup> 1 barrel (US) = 158.987 dm <sup>3</sup>	1 m <sup>3</sup> = 10 <sup>3</sup> ℓ 1 m <sup>3</sup> = 10 <sup>6</sup> cc 1 m <sup>3</sup> = 264.17 gal 1 m <sup>3</sup> = 33 814 floz 1 m <sup>3</sup> = 6.289 8 barrel
Time	s [second(s)]	min [minute(s)] ※ h [hour(s)] ※ d [day(s)] ※		
Angular velocity	rad/s			
Angular acceleration	rad/s <sup>2</sup>			
Velocity, speed	m/s	kn [knot(s)] ※※	1 kn = 1 852 m/h	1 km/h = 0.539 96 kn
Acceleration	m/s <sup>2</sup>	G	1 G = 9.806 65 m/s <sup>2</sup>	1 m/s <sup>2</sup> = 0.101 97 G
Frequency	Hz [hertz]	c/s [cycle(s)/second]	1 c/s = 1 s <sup>-1</sup> = 1 Hz	
Rotational speed	s <sup>-1</sup>	min <sup>-1</sup> [revolutions per minute]	1 min <sup>-1</sup> = 1/60 s <sup>-1</sup>	1 s <sup>-1</sup> = 60 min <sup>-1</sup>
Mass	kg [kilogram(s)]	t [ton(s)] lb [pound(s)] gr [grain(s)] oz [ounce(s)] ton (UK) [ton(s) (UK)] ton (US) [ton(s) (US)] car [carat(s)]	1 t = 10 <sup>3</sup> kg 1 lb = 0.453 592 37 kg 1 gr = 64.798 91 mg 1 oz = 1/16 lb = 28.349 5 g 1 ton (UK) = 1 016.05 kg 1 ton (US) = 907.185 kg 1 car = 200 mg	1 kg = 2.204 6 lb 1 g = 15.432 4 gr 1 kg = 35.274 0 oz 1 t = 0.984 2 ton (UK) 1 t = 1.102 3 ton (US) 1 g = 5 car

Note 1) ※ : Unit can be used as an SI unit.  
 ※※ : Unit can be used as an SI unit for the time being.  
 No asterisk : unit cannot be used.



# Supplementary Table 6 SI Units and Conversion Factors

Supplementary Table 6 (2) SI Units and Conversion Factors

Mass	SI units	Other units <sup>1)</sup>	Conversion into SI units	Conversion from SI units
Density	kg/m <sup>3</sup>			
Linear density	kg/m			
Momentum	kg·m/s			
Moment of momentum, angular momentum	} kg·m <sup>2</sup> /s			
Moment of inertia		kg·m <sup>2</sup>		
Force	N [newton(s)]	dyn [dyne(s)] kgf [kilogram-force] gf [gram-force] tf [ton-force] lbf [pound-force]	1 dyn = 10 <sup>-5</sup> N 1 kgf = 9.806 65 N 1 gf = 9.806 65 × 10 <sup>-3</sup> N 1 tf = 9.806 65 × 10 <sup>3</sup> N 1 lbf = 4.448 22 N	1 N = 10 <sup>5</sup> dyn 1 N = 0.101 97 kgf 1 N = 0.224 809 lbf
Moment of force, torque	N·m [Newton meter(s)]	gf·cm kgf·cm kgf·m tf·m ft·lbf	1 gf·cm = 9.806 65 × 10 <sup>-5</sup> N·m 1 kgf·cm = 9.806 65 × 10 <sup>-2</sup> N·m 1 kgf·m = 9.806 65 N·m 1 tf·m = 9.806 65 × 10 <sup>3</sup> N·m 1 ft·lbf = 1.355 82 N·m	1 N·m = 0.101 97 kgf·m 1 N·m = 0.737 56 ft·lbf
Pressure, stress	Pa [Pascal(s)]  or N/m <sup>2</sup> {1 Pa = 1 N/m <sup>2</sup> }	gf/cm <sup>2</sup> kgf/mm <sup>2</sup> kgf/m <sup>2</sup> lbf/in <sup>2</sup> bar [bar(s)] at [engineering air pressure] mH <sub>2</sub> O, mAq [meter water column] atm [atmosphere] mHg [meter mercury column] Torr [torr]	1 gf/cm <sup>2</sup> = 9.806 65 × 10 Pa 1 kgf/mm <sup>2</sup> = 9.806 65 × 10 <sup>6</sup> Pa 1 kgf/m <sup>2</sup> = 9.806 65 Pa 1 lbf/in <sup>2</sup> = 6 894.76 Pa 1 bar = 10 <sup>5</sup> Pa 1 at = 1 kgf/cm <sup>2</sup> = 9.806 65 × 10 <sup>4</sup> Pa 1 mH <sub>2</sub> O = 9.806 65 × 10 <sup>3</sup> Pa 1 atm = 101 325 Pa 1 mHg = $\frac{101\ 325}{0.76}$ Pa 1 Torr = 1 mmHg = 133.322 Pa	1 Pa = 0.101 97 kgf/m <sup>2</sup> 1 MPa = 0.101 97 kgf/mm <sup>2</sup>  1 Pa = 0.145 × 10 <sup>-3</sup> lbf/in <sup>2</sup> 1 Pa = 10 <sup>-2</sup> mbar  1 Pa = 7.500 6 × 10 <sup>-3</sup> Torr
Viscosity	Pa·s [pascal second]	P [poise]      ※※ kgf·s/m <sup>2</sup>	10 <sup>-2</sup> P = 1 cP = 1 mPa·s 1 kgf·s/m <sup>2</sup> = 9.806 65 Pa·s	1 Pa·s = 0.101 97 kgf·s/m <sup>2</sup>
Kinematic viscosity	m <sup>2</sup> /s	St [stokes]      ※※	10 <sup>-2</sup> St = 1 cSt = 1 mm <sup>2</sup> /s	
Surface tension	N/m			

Note 1)

※ : Unit can be used as an SI unit.

※※ : Unit can be used as an SI unit for the time being.

No asterisk : unit cannot be used.

Supplementary Table 6 (3) SI Units and Conversion Factors

Mass	SI units	Other Units <sup>1)</sup>	Conversion into SI units	Conversion from SI units
Work, energy	J [joule(s)] W·s [watt(s) second]  { 1 J = 1 N·m 1 W·s = 1 J }	eV [electron volt(s)] ※ erg [erg(s)] kgf·m ft·lbf	1 eV = (1.6021892 ± 0.0000046) × 10 <sup>-19</sup> J 1 erg = 10 <sup>-7</sup> J 1 kgf·m = 9.806 65 J 1 ft·lbf = 1.355 82 J	1 J = 10 <sup>7</sup> erg 1 J = 0.101 97 kgf·m 1 J = 0.737 56 ft·lbf
Power	W [watt(s)]  { 1 W = 1 J/s }	erg/s [ergs per second] kgf·m/s ps [French horse-power] HP [horse-power (British)] ft·lbf/s	1 erg/s = 10 <sup>-7</sup> W 1 kgf·m/s = 9.806 65 W 1 PS = 75 kgf·m/s = 735.5 W 1 HP = 550 ft·lbf/s = 745.7 W 1 ft·lbf/s = 1.355 82 W	1 W = 0.101 97 kgf·m/s 1 W = 0.001 36 PS 1 W = 0.001 34 HP
Temperature	K [kelvin(s)]	°C [degree(s) Celsius] ※ °F [degree(s) Fahrenheit]	t °C = (t + 273.15) K t °F = $\frac{5}{9}(t - 32)$ °C	t K = (t - 273.15) °C t °C = $(\frac{9}{5}t + 32)$ °F
Temperature difference	K [kelvin(s)]	°C [degree(s) Celsius] ※	1 °C = 1 K	1 K = 1 °C
Linear expansion coefficient	K <sup>-1</sup> [per kelvin]	°C <sup>-1</sup> [per degree] ※		
Heat	J [joule(s)] W·s [watt(s) second]  { 1 J = 1 W·s }	erg [erg(s)] kgf·m cal [calories]  cal <sub>15</sub> [15 degree calories] cal <sub>IT</sub> [I. T. calories]	1 erg = 10 <sup>-7</sup> J  1 cal = 4.186 05 J (when temperature is not specified) 1 cal <sub>15</sub> = 4.185 5 J 1 cal <sub>IT</sub> = 4.186 J 1 Mcal <sub>IT</sub> = 1.163 kW·h	1 J = 10 <sup>7</sup> erg 1 J = 0.238 89 cal 1 kW·h = 0.86 × 10 <sup>6</sup> cal
Thermal conductivity	W/(m·K)	W/(m·°C) ※ cal/(s·m·°C)	1 W/(m·°C) = 1 W/(m·K) 1 cal/(s·m·°C) = 4.186 05 W/(m·K)	
Coefficient of heat transfer	W/(m <sup>2</sup> ·K)	W/(m <sup>2</sup> ·°C) ※ cal/(s·m <sup>2</sup> ·°C)	1 W/(m <sup>2</sup> ·°C) = 1 W/(m <sup>2</sup> ·K) 1 cal/(s·m <sup>2</sup> ·°C) = 4.186 05 W/(m <sup>2</sup> ·K)	
Heat capacity	J/K	J/°C ※	1 J/°C = 1 J/K	
Specific heat capacity	J/(kg·K)	J/(kg·°C) ※		

Note 1) ※ : Unit can be used as an SI unit.  
 ※※ : Unit can be used as an SI unit for the time being.  
 No asterisk : Unit cannot be used.

# Supplementary Table 6 SI Units and Conversion Factors

Supplementary Table 6 (4) SI Units and Conversion Factors

Mass	SI units	Other units <sup>1)</sup>	Conversion into SI units	Conversion from SI units
Electric current	A [ampere(s)]			
Electric charge, quantity of electricity	C [coulomb(s)] {1 C = 1 A·s}	A·h ※	1 A·h = 3.6 kC	
Tension, electric potential	V [volt(s)] {1 V = 1 W/A}			
Capacitance	F [farad(s)] {1 F = 1 C/V}			
Magnetic field strength	A/m	Oe [oersted(s)]	$1 \text{ Oe} = \frac{10^3}{4\pi} \text{ A/m}$	$1 \text{ A/m} = 4\pi \times 10^{-3} \text{ Oe}$
Magnetic flux density	T [tesla(s)] {1 T = 1 N/(A·m) = 1 Wb/m <sup>2</sup> = 1 V·s/m <sup>2</sup> }	Gs [gauss(es)] $\gamma$ [gamma(s)]	1 Gs = 10 <sup>-4</sup> T 1 $\gamma$ = 10 <sup>-9</sup> T	1 T = 10 <sup>4</sup> Gs 1 T = 10 <sup>9</sup> $\gamma$
Magnetic flux	Wb [weber(s)] {1 Wb = 1 V·s}	Mx [maxwell(s)]	1 Mx = 10 <sup>-8</sup> Wb	1 Wb = 10 <sup>8</sup> Mx
Self inductance	H [henry (-ries)] {1 H = 1 Wb/A}			
Resistance	$\Omega$ [ohm(s)] {1 $\Omega$ = 1 V/A}			
Conductance	S [siemens] {1 S = 1 A/V}			
Power	W {1 W = 1 J/s = 1 A·V}			

Note 1)

※ : Unit can be used as an SI unit.

※※ : Unit can be used as an SI unit for the time being.

No asterisk : Unit cannot be used.



Supplementary Table 7 Inch / Millimeter Conversion

Inch		Inches										
		0	1	2	3	4	5	6	7	8	9	10
		mm										
<b>0</b>	<b>0</b>	<b>0</b>	<b>25.4000</b>	<b>50.8000</b>	<b>76.2000</b>	<b>101.6000</b>	<b>127.0000</b>	<b>152.4000</b>	<b>177.8000</b>	<b>203.2000</b>	<b>228.6000</b>	<b>254.0000</b>
<b>1/64</b>	0.015625	0.3969	25.7969	51.1969	76.5969	101.9969	127.3969	152.7969	178.1969	203.5969	228.9969	254.3969
<b>1/32</b>	0.03125	0.7938	26.1938	51.5938	76.9938	102.3938	127.7938	153.1938	178.5938	203.9938	229.3938	254.7938
<b>3/64</b>	0.046875	1.1906	26.5906	51.9906	77.3906	102.7906	128.1906	153.5906	178.9906	204.3906	229.7906	255.1906
<b>1/16</b>	0.0625	1.5875	26.9875	52.3875	77.7875	103.1875	128.5875	153.9875	179.3875	204.7875	230.1875	255.5875
<b>5/64</b>	0.078125	1.9844	27.3844	52.7844	78.1844	103.5844	128.9844	154.3844	179.7844	205.1844	230.5844	255.9844
<b>3/32</b>	0.09375	2.3812	27.7812	53.1812	78.5812	103.9812	129.3812	154.7812	180.1812	205.5812	230.9812	256.3812
<b>7/64</b>	0.109375	2.7781	28.1781	53.5781	78.9781	104.3781	129.7781	155.1781	180.5781	205.9781	231.3781	256.7781
<b>1/8</b>	0.125	<b>3.1750</b>	<b>28.5750</b>	<b>53.9750</b>	<b>79.3750</b>	<b>104.7750</b>	<b>130.1750</b>	<b>155.5750</b>	<b>180.9750</b>	<b>206.3750</b>	<b>231.7750</b>	<b>257.1750</b>
<b>9/64</b>	0.140625	3.5719	28.9719	54.3719	79.7719	105.1719	130.5719	155.9719	181.3719	206.7719	232.1719	257.5719
<b>5/32</b>	0.15625	3.9688	29.3688	54.7688	80.1688	105.5688	130.9688	156.3688	181.7688	207.1688	232.5688	257.9688
<b>11/64</b>	0.171875	4.3656	29.7656	55.1656	80.5656	105.9656	131.3656	156.7656	182.1656	207.5656	232.9656	258.3656
<b>3/16</b>	0.1875	4.7625	30.1625	55.5625	80.9625	106.3625	131.7625	157.1625	182.5625	207.9625	233.3625	258.7625
<b>13/64</b>	0.203125	5.1594	30.5594	55.9594	81.3594	106.7594	132.1594	157.5594	182.9594	208.3594	233.7594	259.1594
<b>7/32</b>	0.21875	5.5562	30.9562	56.3562	81.7562	107.1562	132.5562	157.9562	183.3562	208.7562	234.1562	259.5562
<b>15/64</b>	0.234375	5.9531	31.3531	56.7531	82.1531	107.5531	132.9531	158.3531	183.7531	209.1531	234.5531	259.9531
<b>1/4</b>	0.25	<b>6.3500</b>	<b>31.7500</b>	<b>57.1500</b>	<b>82.5500</b>	<b>107.9500</b>	<b>133.3500</b>	<b>158.7500</b>	<b>184.1500</b>	<b>209.5500</b>	<b>234.9500</b>	<b>260.3500</b>
<b>17/64</b>	0.265625	6.7469	32.1469	57.5469	82.9469	108.3469	133.7469	159.1469	184.5469	209.9469	235.3469	260.7469
<b>9/32</b>	0.28125	7.1438	32.5438	57.9438	83.3438	108.7438	134.1438	159.5438	184.9438	210.3438	235.7438	261.1438
<b>19/64</b>	0.296875	7.5406	32.9406	58.3406	83.7406	109.1406	134.5406	159.9406	185.3406	210.7406	236.1406	261.5406
<b>5/16</b>	0.3125	7.9375	33.3375	58.7375	84.1375	109.5375	134.9375	160.3375	185.7375	211.1375	236.5375	261.9375
<b>21/64</b>	0.328125	8.3344	33.7344	59.1344	84.5344	109.9344	135.3344	160.7344	186.1344	211.5344	236.9344	262.3344
<b>11/32</b>	0.34375	8.7312	34.1312	59.5312	84.9312	110.3312	135.7312	161.1312	186.5312	211.9312	237.3312	262.7312
<b>23/64</b>	0.359375	9.1281	34.5281	59.9281	85.3281	110.7281	136.1281	161.5281	186.9281	212.3281	237.7281	263.1281
<b>3/8</b>	0.375	<b>9.5250</b>	<b>34.9250</b>	<b>60.3250</b>	<b>85.7250</b>	<b>111.1250</b>	<b>136.5250</b>	<b>161.9250</b>	<b>187.3250</b>	<b>212.7250</b>	<b>238.1250</b>	<b>263.5250</b>
<b>25/64</b>	0.390625	9.9219	35.3219	60.7219	86.1219	111.5219	136.9219	162.3219	187.7219	213.1219	238.5219	263.9219
<b>13/32</b>	0.40625	10.3188	35.7188	61.1188	86.5188	111.9188	137.3188	162.7188	188.1188	213.5188	238.9188	264.3188
<b>27/64</b>	0.421875	10.7156	36.1156	61.5156	86.9156	112.3156	137.7156	163.1156	188.5156	213.9156	239.3156	264.7156
<b>7/16</b>	0.4375	11.1125	36.5125	61.9125	87.3125	112.7125	138.1125	163.5125	188.9125	214.3125	239.7125	265.1125
<b>29/64</b>	0.453125	11.5094	36.9094	62.3094	87.7094	113.1094	138.5094	163.9094	189.3094	214.7094	240.1094	265.5094
<b>15/32</b>	0.46875	11.9062	37.3062	62.7062	88.1062	113.5062	138.9062	164.3062	189.7062	215.1062	240.5062	265.9062
<b>31/64</b>	0.484375	12.3031	37.7031	63.1031	88.5031	113.9031	139.3031	164.7031	190.1031	215.5031	240.9031	266.3031
<b>1/2</b>	0.5	<b>12.7000</b>	<b>38.1000</b>	<b>63.5000</b>	<b>88.9000</b>	<b>114.3000</b>	<b>139.7000</b>	<b>165.1000</b>	<b>190.5000</b>	<b>215.9000</b>	<b>241.3000</b>	<b>266.7000</b>
<b>33/64</b>	0.515625	13.0969	38.4969	63.8969	89.2969	114.6969	140.0969	165.4969	190.8969	216.2969	241.6969	267.0969
<b>17/32</b>	0.53125	13.4938	38.8938	64.2938	89.6938	115.0938	140.4938	165.8938	191.2938	216.6938	242.0938	267.4938
<b>35/64</b>	0.546875	13.8906	39.2906	64.6906	90.0906	115.4906	140.8906	166.2906	191.6906	217.0906	242.4906	267.8906
<b>9/16</b>	0.5625	14.2875	39.6875	65.0875	90.4875	115.8875	141.2875	166.6875	192.0875	217.4875	242.8875	268.2875
<b>37/64</b>	0.578125	14.6844	40.0844	65.4844	90.8844	116.2844	141.6844	167.0844	192.4844	217.8844	243.2844	268.6844
<b>19/32</b>	0.59375	15.0812	40.4812	65.8812	91.2812	116.6812	142.0812	167.4812	192.8812	218.2812	243.6812	269.0812
<b>39/64</b>	0.609375	15.4781	40.8781	66.2781	91.6781	117.0781	142.4781	167.8781	193.2781	218.6781	244.0781	269.4781
<b>5/8</b>	0.625	<b>15.8750</b>	<b>41.2750</b>	<b>66.6750</b>	<b>92.0750</b>	<b>117.4750</b>	<b>142.8750</b>	<b>168.2750</b>	<b>193.6750</b>	<b>219.0750</b>	<b>244.4750</b>	<b>269.8750</b>
<b>41/64</b>	0.640625	16.2719	41.6719	67.0719	92.4719	117.8719	143.2719	168.6719	194.0719	219.4719	244.8719	270.2719
<b>21/32</b>	0.65625	16.6688	42.0688	67.4688	92.8688	118.2688	143.6688	169.0688	194.4688	219.8688	245.2688	270.6688
<b>43/64</b>	0.671875	17.0656	42.4656	67.8656	93.2656	118.6656	144.0656	169.4656	194.8656	220.2656	245.6656	271.0656
<b>11/16</b>	0.6875	17.4625	42.8625	68.2625	93.6625	119.0625	144.4625	169.8625	195.2625	220.6625	246.0625	271.4625
<b>45/64</b>	0.703125	17.8594	43.2594	68.6594	94.0594	119.4594	144.8594	170.2594	195.6594	221.0594	246.4594	271.8594
<b>23/32</b>	0.71875	18.2562	43.6562	69.0562	94.4562	119.8562	145.2562	170.6562	196.0562	221.4562	246.8562	272.2562
<b>47/64</b>	0.734375	18.6531	44.0531	69.4531	94.8531	120.2531	145.6531	171.0531	196.4531	221.8531	247.2531	272.6531
<b>3/4</b>	0.75	<b>19.0500</b>	<b>44.4500</b>	<b>69.8500</b>	<b>95.2500</b>	<b>120.6500</b>	<b>146.0500</b>	<b>171.4500</b>	<b>196.8500</b>	<b>222.2500</b>	<b>247.6500</b>	<b>273.0500</b>
<b>49/64</b>	0.765625	19.4469	44.8469	70.2469	95.6469	121.0469	146.4469	171.8469	197.2469	222.6469	248.0469	273.4469
<b>25/32</b>	0.78125	19.8438	45.2438	70.6438	96.0438	121.4438	146.8438	172.2438	197.6438	223.0438	248.4438	273.8438
<b>51/64</b>	0.796875	20.2406	45.6406	71.0406	96.4406	121.8406	147.2406	172.6406	198.0406	223.4406	248.8406	274.2406
<b>13/16</b>	0.8125	20.6375	46.0375	71.4375	96.8375	122.2375	147.6375	173.0375	198.4375	223.8375	249.2375	274.6375
<b>53/64</b>	0.828125	21.0344	46.4344	71.8344	97.2344	122.6344	148.0344	173.4344	198.8344	224.2344	249.6344	275.0344
<b>27/32</b>	0.84375	21.4312	46.8312	72.2312	97.6312	123.0312	148.4312	173.8312	199.2312	224.6312	250.0312	275.4312
<b>55/64</b>	0.859375	21.8281	47.2281	72.6281	98.0281	123.4281	148.8281	174.2281	199.6281	225.0281	250.4281	275.8281
<b>7/8</b>	0.875	<b>22.2250</b>	<b>47.6250</b>	<b>73.0250</b>	<b>98.4250</b>	<b>123.8250</b>	<b>149.2250</b>	<b>174.6250</b>	<b>200.0250</b>	<b>225.4250</b>	<b>250.8250</b>	<b>276.2250</b>
<b>57/64</b>	0.890625	22.6219	48.0219	73.4219	98.8219	124.2219	149.6219	175.0219	200.4219	225.8219	251.2219	276.6219
<b>29/32</b>	0.90625	23.0188	48.4188	73.8188	99.2188	124.6188	150.0188	175.4188	200.8188	226.2188	251.6188	277.0188
<b>59/64</b>	0.921875	23.4156	48.8156	74.2156	99.6156	125.0156	150.4156	175.8156	201.2156	226.6156	252.0156	277.4156
<b>15/16</b>	0.9375	23.8125	49.2125	74.6125	100.0125	125.4125	150.8125	176.2125	201.6125	227.0125	252.4125	277.8125
<b>61/64</b>	0.953125	24.2094	49.6094	75.0094	100.4094	125.8094	151.2094	176.6094	202.0094	227.4094	252.8094	278.2094
<b>31/32</b>	0.96875	24.6062	50.0062	75.4062	100.8062	126.2062	151.6062	177.0062	202.4062	227.8062	253.2062	278.6062
<b>63/64</b>	0.984375	25.0031	50.4031	75.8031	101.2031	126.6031	152.0031	1				



# Supplementary Table 8 Steel Hardness Conversion

Supplementary Table 8 Steel Hardness Conversion

Rockwell	Vicker's	Brinell		Rockwell		Shore
C-scale 1 417 N		Standard ball	Tungsten carbide ball	A-scale 588.4 N	B-scale 980.7 N	
68	940			85.6		97
67	900			85.0		95
66	865			84.5		92
65	832		739	83.9		91
64	800		722	83.4		88
63	772		705	82.8		87
62	746		688	82.3		85
61	720		670	81.8		83
60	697		654	81.2		81
59	674		634	80.7		80
58	653		615	80.1		78
57	633		595	79.6		76
56	613		577	79.0		75
55	595	—	560	78.5		74
54	577	—	543	78.0		72
53	560	—	525	77.4		71
52	544	500	512	76.8		69
51	528	487	496	76.3		68
50	513	475	481	75.9		67
49	498	464	469	75.2		66
48	484	451	455	74.7		64
47	471	442	443	74.1		63
46	458	432	432	73.6		62
45	446	421	421	73.1		60
44	434	409	409	72.5		58
43	423	400	400	72.0		57
42	412	390	390	71.5		56
41	402	381	381	70.9		55
40	392	371	371	70.4	—	54
39	382	362	362	69.9	—	52
38	372	353	353	69.4	—	51
37	363	344	344	68.9	—	50
36	354	336	336	68.4	(109.0)	49
35	345	327	327	67.9	(108.5)	48
34	336	319	319	67.4	(108.0)	47
33	327	311	311	66.8	(107.5)	46
32	318	301	301	66.3	(107.0)	44
31	310	294	294	65.8	(106.0)	43
30	302	286	286	65.3	(105.5)	42
29	294	279	279	64.7	(104.5)	41
28	286	271	271	64.3	(104.0)	41
27	279	264	264	63.8	(103.0)	40
26	272	258	258	63.3	(102.5)	38
25	266	253	253	62.8	(101.5)	38
24	260	247	247	62.4	(101.0)	37
23	254	243	243	62.0	100.0	36
22	248	237	237	61.5	99.0	35
21	243	231	231	61.0	98.5	35
20	238	226	226	60.5	97.8	34
(18)	230	219	219	—	96.7	33
(16)	222	212	212	—	95.5	32
(14)	213	203	203	—	93.9	31
(12)	204	194	194	—	92.3	29
(10)	196	187	187		90.7	28
( 8)	188	179	179		89.5	27
( 6)	180	171	171		87.1	26
( 4)	173	165	165		85.5	25
( 2)	166	158	158		83.5	24
( 0)	160	152	152		81.7	24

Supplementary Table 9 Viscosity Conversion

Kinematic viscosity mm <sup>2</sup> /s	Saybolt SUS(second)		Redwood R(second)		Engler E(degree)
	100 °F	210 °F	50 °C	100 °C	
2	32.6	32.8	30.8	31.2	1.14
3	36.0	36.3	33.3	33.7	1.22
4	39.1	39.4	35.9	36.5	1.31
5	42.3	42.6	38.5	39.1	1.40
6	45.5	45.8	41.1	41.7	1.48
7	48.7	49.0	43.7	44.3	1.56
8	52.0	52.4	46.3	47.0	1.65
9	55.4	55.8	49.1	50.0	1.75
10	58.8	59.2	52.1	52.9	1.84
11	62.3	62.7	55.1	56.0	1.93
12	65.9	66.4	58.2	59.1	2.02
13	69.6	70.1	61.4	62.3	2.12
14	73.4	73.9	64.7	65.6	2.22
15	77.2	77.7	68.0	69.1	2.32
16	81.1	81.7	71.5	72.6	2.43
17	85.1	85.7	75.0	76.1	2.54
18	89.2	89.8	78.6	79.7	2.64
19	93.3	94.0	82.1	83.6	2.76
20	97.5	98.2	85.8	87.4	2.87
21	102	102	89.5	91.3	2.98
22	106	107	93.3	95.1	3.10
23	110	111	97.1	98.9	3.22
24	115	115	101	103	3.34
25	119	120	105	107	3.46
26	123	124	109	111	3.58
27	128	129	112	115	3.70
28	132	133	116	119	3.82
29	137	138	120	123	3.95
30	141	142	124	127	4.07
31	145	146	128	131	4.20
32	150	150	132	135	4.32
33	154	155	136	139	4.45
34	159	160	140	143	4.57

Kinematic viscosity mm <sup>2</sup> /s	Saybolt SUS(second)		Redwood R(second)		Engler E(degree)
	100 °F	210 °F	50 °C	100 °C	
35	163	164	144	147	4.70
36	168	170	148	151	4.83
37	172	173	153	155	4.96
38	177	178	156	159	5.08
39	181	183	160	164	5.21
40	186	187	164	168	5.34
41	190	192	168	172	5.47
42	195	196	172	176	5.59
43	199	201	176	180	5.72
44	204	205	180	185	5.85
45	208	210	184	189	5.98
46	213	215	188	193	6.11
47	218	219	193	197	6.24
48	222	224	197	202	6.37
49	227	228	201	206	6.50
50	231	233	205	210	6.63
55	254	256	225	231	7.24
60	277	279	245	252	7.90
65	300	302	266	273	8.55
70	323	326	286	294	9.21
75	346	349	306	315	9.89
80	371	373	326	336	10.5
85	394	397	347	357	11.2
90	417	420	367	378	11.8
95	440	443	387	399	12.5
100	464	467	408	420	13.2
120	556	560	490	504	15.8
140	649	653	571	588	18.4
160	742	747	653	672	21.1
180	834	840	734	757	23.7
200	927	933	816	841	26.3
250	1 159	1 167	1 020	1 051	32.9
300	1 391	1 400	1 224	1 241	39.5

(Remark) 1 mm<sup>2</sup>/s=1 cSt (centi stokes)



# Research and Development

## Research and Development



Technical Center (Osaka, Japan)

KOYO SEIKO promotes research and development activities through an excellent research environment featuring advanced research facilities.

We are steadily making improvements in the performance of miniature and extra-small ball bearings, such as low torque, high running accuracy, and longer life.

We are also actively developing new products.



Vibration tester



Surface roughness / form tester



Clean room



Thermo-hydrostatic test chamber

## Plants

With more than 75 years experience, KOYO SEIKO produces bearings using state-of-the-art manufacturing facilities.



MS Project Division (Kagawa, Japan)



KOYO NIDEC (DALIAN)  
PRECISION BEARINGS CO., LTD.  
(Dalian, China)

\* ISO 9002 certified.



WUXI KOYO BEARING CO., LTD.  
(Wuxi, China)

# INTERNATIONAL NETWORK

## **KOYO SEIKO CO., LTD. HEAD OFFICE**

No.5-8, Minamisemba 3-chome, Chuo-ku, Osaka 542-8502, JAPAN  
TEL : 81-6-6245-6087  
FAX : 81-6-6244-0814  
TLX : 63040(KOYO OSJ)

## **KOYO CANADA INC.**

5324 South Service Road, Burlington, Ontario L7L 5H5, CANADA  
TEL : 1-905-681-1121  
FAX : 1-905-681-1392

## **\* KOYO CORPORATION OF U.S.A.**

29570 Clemens Road, P.O.Box 45028, Westlake, OH 44145, U.S.A.  
TEL : 1-440-835-1000  
FAX : 1-440-835-9347  
TLX : 0985461(AMKOY RKVR)

## **\* KOYO CORPORATION OF U.S.A.**

### **(AUTO SALES & TECHNICAL CENTER)**

47771 Halyard Drive, Plymouth, MI 48170, U.S.A.  
TEL : 1-734-454-1500  
FAX : 1-734-454-4076

## **KOYO STEERING SYSTEMS OF U.S.A. INC.**

47771 Halyard Drive, Plymouth, MI 48170, U.S.A.  
TEL : 1-734-454-7067  
FAX : 1-734-454-7059

## **KOYO DE MÉXICO, S.A.**

Av. Primero de Mayo No.153, 53500 Naucalpan Edo.de México, MÉXICO  
TEL : 52-5-358-0214, 0077  
FAX : 52-5-576-8827, 8871

## **KOYO LATIN AMERICA, S.A.**

Edificio Banco del Pacifico Planta Baja, Calle Aquilino de La Guardia y  
Calle 52, Panama, REPUBLICA DE PANAMA  
P.O.Box 6-1797, El Dorado, Panama, REPUBLICA DE PANAMA  
TEL : 507-264-0921, 0977  
FAX : 507-264-2782, 507-269-7578

## **KOYO ROLAMENTOS DO BRASIL LTDA.**

Rua Desembargador Eliseu Ghilherme 304, 7-Andar, Paraiso CEP 04004-30, BRASIL  
TEL : 55-11-887-9173  
FAX : 55-11-887-3039

## **THAI KOYO CO., LTD.**

193/53 Lake Rajada Office Complex 14th Floor Unit B, Rachadapisek Road,  
Klongtoey, Bangkok 10110 THAILAND  
TEL : 66-2-264-0395, 66-2-661-9603-5  
FAX : 66-2-661-9606

## **KOYO SINGAPORE BEARING (PTE.) LTD.**

38 Tuas West Road, Singapore 638385, SINGAPORE  
TEL : 65-274-2200  
FAX : 65-862-1623

## **PHILIPPINE KOYO BEARING CORPORATION**

Rm.504, Comfoods Bldg., Cor. Gil Puyat Ave. and Pasong Tamo, Makati  
City, PHILIPPINES  
TEL : 63-2-817-8881, 8901  
FAX : 63-2-867-3148

## **KOYO SEIKO CO., LTD. SEOUL BRANCH**

Inwoo Building 6F, 539-11, Shinsa-Dong, Kangnam-Ku, Seoul, KOREA  
TEL : 82-2-549-7922  
FAX : 82-2-549-7923

## **KOYO SEIKO CO., LTD. BEIJING LIAISON OFFICE**

Peace Hotel Room 2804, No.3 JinYu HuTong, Beijing, CHINA  
TEL : 86-10-6512-5673, 9401  
FAX : 86-10-6512-5674

## **KOYO AUSTRALIA PTY. LTD.**

Unit 7, 175-179 James Ruse Drive, Rosehill, 2142 N.S.W., AUSTRALIA  
P.O.Box 442, Rydalmere, 2116 N.S.W., AUSTRALIA  
TEL : 61-2-9638-2355  
FAX : 61-2-9638-3368

## **KOYO SEIKO CO., LTD. EUROPEAN CENTRAL OFFICE**

Markerkant 13-01, 1314 AL, Almere, THE NETHERLANDS  
TEL : 31-36-5383333  
FAX : 31-36-5347212

## **KOYO KULLAGER SCANDINAVIA A.B.**

Kanalvägen 1B, 194 61 Upplands-Väsby, SWEDEN  
TEL : 46-8-590-341-85  
FAX : 46-3-590-309-69

## **KOYO (U.K.) LTD.**

Whitehall Avenue, Kingston, Milton Keynes MK10 OAX, UNITED KINGDOM  
TEL : 44-1908-289300  
FAX : 44-1908-289333

## **EUROPA-KOYO B.V.**

Lekdijk 187-2967 GJ Langerak, Nieuwpoort, THE NETHERLANDS  
P.O.Box 1-2965 ZG, Nieuwpoort, THE NETHERLANDS  
TEL : 31-184-606800  
FAX : 31-184-602572, 606857

## **KOYO ROMANIA REPRESENTATIVE OFFICE**

Str. Frederic Jolliot-Curie, Nr.3, Etaj 1, Ap.2, Sector 5 Bucharest, ROMANIA  
TEL : 40-1-410-4170, 4182, 0984  
FAX : 40-1-410-1178

## **KOYO DEUTSCHLAND GMBH.**

Bargkoppelweg 4, D-22145 Hamburg, GERMANY  
P.O.Box 73 06 60, D-22126 Hamburg, GERMANY  
TEL : 49-40-67-9090-0  
FAX : 49-40-67-9203-0  
TLX : 213138(KOYO D)

## **KOYO FRANCE S.A.**

8 Rue Guy Moquet, B.P.189 Z.I., 95105 Argenteuil Cedex, FRANCE  
TEL : 33-1-3998-4222  
FAX : 33-1-3998-4244, 4249

## **KOYO IBERICA, S.A**

Calle Aramayona S/N, Naves 1 y 2, Poligono Industrial "Las Mercedes",  
28022 Madrid, SPAIN  
TEL : 34-91-329-0818  
FAX : 34-91-747-1194

## **KOYO ITALIA S.R.L.**

Via Bronzino 9, 20133 Milano, ITALY  
TEL : 39-02-2951-0844  
FAX : 39-02-2951-0954

( KOYO SEIKO CO., LTD. (Japan) is certified to ISO9001. )

\*ISO9002 certified.



# MINIATURE AND EXTRA-SMALL BALL BEARINGS



**VALUE & TECHNOLOGY**